

VIDMAR PRODUCT CATALOG

PRODUCT CATALOG

Rugged. Versatile. Custom Designed.



Align bottom edge of ruler to inside base of drawer.

VIDMAR[®] DRAWER DEPTH RULER

70
60
50
45
40
35
30
25
20



Smart Versatile Storage.

SWSVIDCAT15

©2015 Vidmar

STANLEY

VIDMAR: Table of Contents

VIDMAR

For more than 40 years, Vidmar has meant one thing to customers around the world—heavy-duty storage solutions for heavy-duty applications.

Swiss manufacturer A&R Weidemar introduced the first modular-drawer cabinet in the 1940s in the form of a tool crib composed of enclosed steel storage modules that held full-suspension heavy-duty drawers. When introduced to these tool cribs, John Kleinoder, a Brooklyn-based tool and die maker, saw them as the perfect solution for storing metal working tools. He also saw that they were much more than toolboxes, and knew that their potential market went well beyond machine shops.

In 1958, Kleinoder arranged to manufacture Weidemar cabinets in the United States under the name “Vidmar.” In 1962, Vidmar cabinets became part of the first photocopiers made by Haloid Corporation, which would become Xerox Corporation. In 1965, Xerox asked Vidmar to open a plant in Allentown, Pennsylvania. A year later, Kleinoder sold the company to The Stanley Works, now known as Stanley Black & Decker of New Britain, Connecticut.

Today, Vidmar, as the company is now known, still makes all of our products to order at our Allentown facility. In the years that have passed since our inception in 1966, Vidmar has watched the demand for efficient, durable storage continue to grow and grow as businesses and industries become more space-, cost-, and productivity-conscious. Vidmar is a common name in countless fields, including military, automotive, manufacturing, healthcare, heavy equipment, agricultural, power generation/utilities, government (GSA Contract #GS-27F-5062C), and many more.

Whether it's preconfigured or custom-configured storage cabinets, workstations and technical benching, mobile cabinets and toolboxes, mezzanines, vertical automated storage and retrieval systems, adjustable rackings systems, or seating, professionals worldwide depend on Vidmar for productivity improvements that directly contribute to a healthier bottom line. Couple this with a knowledgeable, highly trained team of Territory Sales Managers that can guide, train, and make recommendations on all aspects of the Vidmar product offering—including onsite, no-obligation surveys—and you have a turnkey solution that dramatically reduces the time required between initial concept and final implementation. Superior products, innovative solutions, and an unmatched knowledge base all combine to deliver the type of ROI that's critical to staying competitive in today's market. This winning combination has positioned the Vidmar brand as the market leader it is today.

About Vidmar: A division of Stanley Black & Decker, Vidmar offers storage solutions to all industries, with modular space-saving systems that provide quick, safe access to parts, tools, and supplies. A Vidmar system can maximize valuable floor space while providing an integrated solution for inventory control. Customers can arrange a free analysis of their storage needs by calling 800-523-9462. Detailed information on Vidmar products is available at STANLEYVidmar.com



VIDMAR

Introduction	opposite
Table of Contents	page 1
Value Proposition	page 2
Industry Applications	page 4

CABINETS

Preconfigured Cabinets	page 6
How to Configure	page 28
Housing Features & Accessories	page 30
Drawer Features & Accessories	page 32
Roll-Out Shelf/Roll-Out Tray	page 38
Shelf/Shelf Door Cabinets	page 40
Overhead Cabinets	page 42
Mobile Cabinets	page 44
Workcenters/Toolboxes	page 48
Pass-Through & Computer Cabinets	page 52
Safety Cabinets	page 53
Mezzanine	page 54

SPECIALTY STORAGE

Weapons Storage	page 56
Rapid Deployment Container Insert	page 58
Lockers	page 59
StaticGard/ESD	page 60
6S	page 64
NC Tool Storage	page 66
Desks	page 70

WORKSTATIONS & BENCHING

Preconfigured	page 72
Bench Legs	page 76
Stringers, Footrests & Footrest Shelves	page 77
Modesty Panels & Stops	page 78
Outlets & Lights	page 79
Risers & Back Panels	page 80
Work Surfaces	page 82
Overhead Benching Cabinets/Bookcases	page 84
Under-Bench Cabinets	page 85
Technical Bench Cabinets	page 86
Nexus	page 90

CHAIRS

page 106

VERTICAL STORAGE SOLUTIONS

Adjustable Racking	page 108
STAK System®	page 110
Tower	page 114
Carousels	page 116

PAINT FINISHES

page 120

QUICKSHIP

page 121

ACCESSORIES/SPARE PARTS

page 122

SO YOU'VE HEARD THAT VIDMAR OFFERS SOME OF THE WORLD'S TOUGHEST STORAGE SOLUTIONS. BUT BEYOND UNSURPASSED RUGGEDNESS, WHAT ARE THE "BIG BENEFITS" OF CHOOSING VIDMAR? FROM EXTREME SPACE SAVINGS TO INCREASED PRODUCTIVITY, VIDMAR IS THE ULTIMATE USE OF YOUR STORAGE SPACE.

Problem

Have your storage needs outgrown your existing footprint? Are you restricted by limited floor space? Is your inventory unorganized? Does it take you too long to find necessary parts? Do you need to lock and secure valuable equipment? If any of these scenarios sound familiar, Vidmar has your solution.

Solution

Vidmar improves every aspect of your workspace with integrated storage systems engineered specifically for your needs. Ergonomic workstations increase employee safety. Adjustable pallet racking can be managed by one operator in as little as two minutes for inventory of various size and shape. And just two high-density drawer cabinets with custom-configured compartments store the same amount of material as five open shelving units. Simply put, Vidmar makes the most of your storage space.

Benefits

Inventory is given specific, identifiable locations, all within easy reach and full view, meaning fast, efficient retrieval. This allows resources to be redeployed to other areas within the facility for greater productivity and throughput.

Enclosed cabinet storage safeguards against dust, dirt, damage, and loss with locked and secure drawers—your sensitive inventory is never compromised.

And as your storage requirements evolve, Vidmar is right there with you providing flexible modular storage solutions that can be infinitely expanded as your needs change.

"All of the parts are in one place, and the high-dollar electronics are securely locked. Everything is easier to locate and the adjustability of the drawers is priceless. This was one of the smartest investments we could have ever made in the department," says Dallas Volvo Truck Center parts manager Mitch Leone.



Vidmar "Big Benefits"



BEFORE

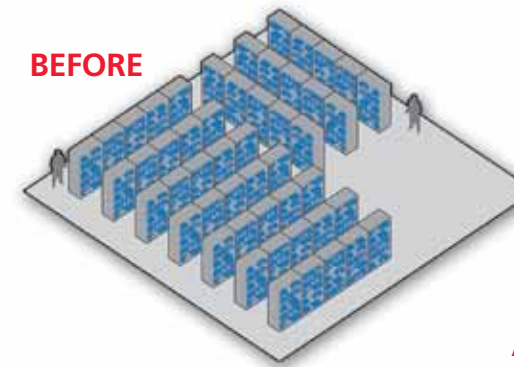

AFTER

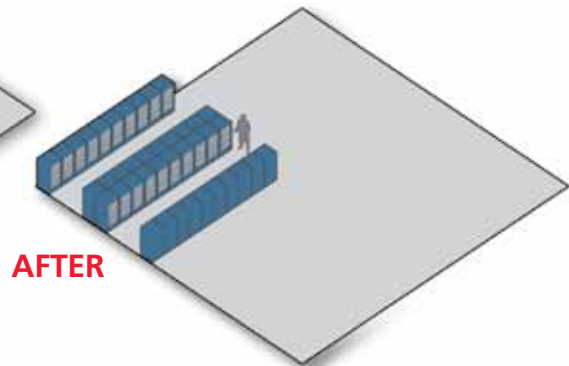

Leverage Your Vertical Space



BEFORE



AFTER





Manufacturing



Manufacturing



Manufacturing



Manufacturing



Automotive



Government



Automotive



Government



Agriculture



Agriculture



SCU3110AL
10 Drawers
184 Compartments
Usable Drawer Heights
3-7/8 in. (98 mm)
5-3/8 in. (137 mm)
567 lbs. (257 kg.) Shipping Weight



SCU3108AL
10 Drawers
192 Compartments
Usable Drawer Heights
3-7/8 in. (98 mm)
4-5/8 in. (117 mm)
5-3/8 in. (137 mm)
535 lbs. (243 kg.) Shipping Weight



SCU3126AL
10 Drawers
188 Compartments
Usable Drawer Heights
2-1/4 in. (57 mm)
3-7/8 in. (98 mm)
5-3/8 in. (137 mm)
8-1/2 in. (216 mm)
563 lbs. (255 kg.) Shipping Weight

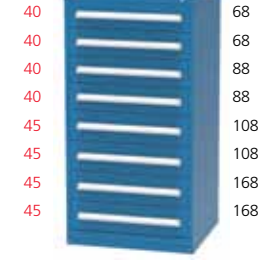

SEP3157AL
8 Drawers
112 Compartments
Usable Drawer Heights
5-3/8 in. (137 mm)
6-1/4 in. (159 mm)
508 lbs. (230 kg.) Shipping Weight



SEP3163AL
8 Drawers
104 Compartments
Usable Drawer Heights
5-3/8 in. (137 mm)
7 in. (178 mm)
508 lbs. (230 kg.) Shipping Weight



SCU3163AL
8 Drawers
120 Compartments
Usable Drawer Heights
5-3/8 in. (137 mm)
7 in. (178 mm)
504 lbs. (229 kg.) Shipping Weight



SEP3371AL
8 Drawers
100 Compartments
Usable Drawer Heights
3-7/8 in. (98 mm)
5-3/8 in. (137 mm)
7 in. (178 mm)
8-1/2 in. (216 mm)
480 lbs. (218 kg.) Shipping Weight

EYE LEVEL HEIGHT CONTINUED

Model 340
59 in. (1499 mm) high
30 in. (762 mm) wide
27-3/4 in. (705 mm) deep

To order cabinets without locks, delete the "L" suffix from the model number (example: SEP3014AL becomes SEP3014A).

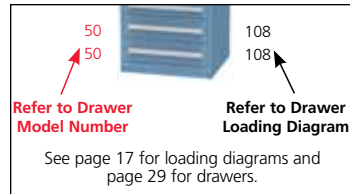

SEP3140AL
9 Drawers
144 Compartments
Usable Drawer Heights
3-7/8 in. (98 mm)
4-5/8 in. (117 mm)
5-3/8 in. (137 mm)
6-1/4 in. (159 mm)
536 lbs. (243 kg.) Shipping Weight



SEP3144AL
9 Drawers
140 Compartments
Usable Drawer Heights
3-7/8 in. (98 mm)
5-3/8 in. (137 mm)
8-1/2 in. (216 mm)
538 lbs. (244 kg.) Shipping Weight



SCU3144AL
9 Drawers
156 Compartments
Usable Drawer Heights
3-7/8 in. (98 mm)
5-3/8 in. (137 mm)
8-1/2 in. (216 mm)
536 lbs. (243 kg.) Shipping Weight



SEP3189AL
7 Drawers
80 Compartments
Usable Drawer Heights
5-3/8 in. (137 mm)
7 in. (178 mm)
472 lbs. (214 kg.) Shipping Weight



SCU3189AL
7 Drawers
88 Compartments
Usable Drawer Heights
5-3/8 in. (137 mm)
7 in. (178 mm)
470 lbs. (213 kg.) Shipping Weight



SCU3389AL
7 Drawers
96 Compartments
Usable Drawer Heights
5-3/8 in. (137 mm)
7 in. (178 mm)
8-1/2 in. (216 mm)
463 lbs. (210 kg.) Shipping Weight



SEP3203AL
6 Drawers
64 Compartments
Usable Drawer Heights
6-1/4 in. (159 mm)
7 in. (178 mm)
8-1/2 in. (216 mm)
11-3/4 in. (292 mm)
436 lbs. (198 kg.) Shipping Weight



SEP3155AL
9 Drawers
144 Compartments
Usable Drawer Heights
2-1/4 in. (57 mm)
3-7/8 in. (98 mm)
7 in. (178 mm)
11-3/4 in. (292 mm)
529 lbs. (240 kg.) Shipping Weight



SCU3352AL
9 Drawers
152 Compartments
Usable Drawer Heights
3-7/8 in. (98 mm)
5-3/8 in. (137 mm)
7 in. (178 mm)
529 lbs. (240 kg.) Shipping Weight



SEP3352AL
9 Drawers
128 Compartments
Usable Drawer Heights
3-7/8 in. (98 mm)
5-3/8 in. (137 mm)
7 in. (178 mm)
529 lbs. (240 kg.) Shipping Weight



SCU3398AL
6 Drawers
72 Compartments
Usable Drawer Heights
7 in. (178 mm)
8-1/2 in. (216 mm)
432 lbs. (196 kg.) Shipping Weight



SCU3399AL
5 Drawers
52 Compartments
Usable Drawer Heights
5-3/8 in. (137 mm)
8-1/2 in. (216 mm)
10-1/8 in. (257 mm)
11-3/4 in. (292 mm)
13-1/4 in. (337 mm)
399 lbs. (181 kg.) Shipping Weight



SEP3214AL
5 Drawers
37 Compartments
Usable Drawer Heights
7 in. (178 mm)
8-1/2 in. (216 mm)
10-1/8 in. (257 mm)
13-1/4 in. (337 mm)
392 lbs. (178 kg.) Shipping Weight



SEP3219AL
4 Drawers
29 Compartments
Usable Drawer Heights
11-3/4 in. (292 mm)
13-1/4 in. (337 mm)
357 lbs. (162 kg.) Shipping Weight



20 48
20 48
20 58
20 58
20 58
20 68
25 68
25 88
25 88
30 88
30 68

SEP2004AL
11 Drawers
248 Compartments
Usable Drawer Heights
2-1/4 in. (57 mm)
3 in. (76 mm)
3-7/8 in. (98 mm)
547 lbs. (248 kg.) Shipping Weight

20 48
20 58
20 58
20 68
25 68
25 88
25 88
30 68
30 88
30 88
30 108

SEP2012AL
10 Drawers
200 Compartments
Usable Drawer Heights
2-1/4 in. (57 mm)
3 in. (76 mm)
3-7/8 in. (98 mm)
513 lbs. (233 kg.) Shipping Weight

20 48
20 58
20 58
20 68
25 68
25 88
30 68
35 88
50 108

SEP2025AL
9 Drawers
184 Compartments
Usable Drawer Heights
2-1/4 in. (57 mm)
3 in. (76 mm)
3-7/8 in. (98 mm)
4-5/8 in. (117 mm)
7 in. (178 mm)
485 lbs. (220 kg.) Shipping Weight

30 68
30 68
30 68
35 68
40 88
40 88
40 88

SCU2043AL
7 Drawers
128 Compartments
Usable Drawer Heights
3-7/8 in. (98 mm)
4-5/8 in. (117 mm)
5-3/8 in. (137 mm)
425 lbs. (193 kg.) Shipping Weight

30 68
30 68
30 68
30 68
35 68
60 108

SCU2089AL
7 Drawers
132 Compartments
Usable Drawer Heights
3-7/8 in. (98 mm)
4-5/8 in. (117 mm)
8-1/2 in. (216 mm)
408 lbs. (185 kg.) Shipping Weight

20 84
25 86
30 86
30 88
40 108
50 168
70 1610

RP2102AL
7 Drawers
114 Compartments
Usable Drawer Heights
2-1/4 in. (57 mm)
3 in. (76 mm)
3-7/8 in. (98 mm)
5-3/8 in. (137 mm)
7 in. (178 mm)
419 lbs. (190 kg.) Shipping Weight

30 84
30 86
35 88
40 88
40 108
70 PS-70

RP2112AL
6 Drawers
98 Compartments
Usable Drawer Heights
3-7/8 in. (98 mm)
4-5/8 in. (117 mm)
5-3/8 in. (137 mm)
10-1/8 in. (257 mm)
397 lbs. (180 kg.) Shipping Weight

COUNTER HEIGHT

Model 245
44 in. (1118 mm) high
30 in. (762 mm) wide
27-3/4 in. (705 mm) deep

To order cabinets without locks, delete the "L" suffix from the model number (example: SEP3014AL becomes SEP3014A).

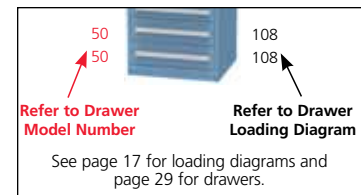

30 68
30 68
30 68
30 68
30 68
30 68
30 68
35 68

SCU2029AL
8 Drawers
160 Compartments
Usable Drawer Heights
3-7/8 in. (98 mm)
4-5/8 in. (117 mm)
455 lbs. (206 kg.) Shipping Weight

30 58
30 58
30 68
30 68
30 68
30 68
30 108
35 108

SEP2029AL
8 Drawers
144 Compartments
Usable Drawer Heights
3-7/8 in. (98 mm)
4-5/8 in. (117 mm)
457 lbs. (207 kg.) Shipping Weight

20 58
20 68
25 88
30 58
30 68
30 68
30 108
30 108
60 108

SEP2037AL
8 Drawers
144 Compartments
Usable Drawer Heights
2-1/4 in. (57 mm)
3 in. (76 mm)
3-7/8 in. (98 mm)
8-1/2 in. (216 mm)
456 lbs. (207 kg.) Shipping Weight

30 86
35 88
40 88
40 108
50 168
50 1610

RP2113AL
6 Drawers
78 Compartments
Usable Drawer Heights
3-7/8 in. (98 mm)
4-5/8 in. (117 mm)
5-3/8 in. (137 mm)
7 in. (178 mm)
390 lbs. (177 kg.) Shipping Weight

30 68
35 68
40 88
40 88
50 108
50 108

SCU2066AL
6 Drawers
96 Compartments
Usable Drawer Heights
3-7/8 in. (98 mm)
4-5/8 in. (117 mm)
5-3/8 in. (137 mm)
7 in. (178 mm)
392 lbs. (178 kg.) Shipping Weight

30 68
35 88
40 88
40 108
50 108
50 168

SEP2066AL
6 Drawers
84 Compartments
Usable Drawer Heights
3-7/8 in. (98 mm)
4-5/8 in. (117 mm)
5-3/8 in. (137 mm)
7 in. (178 mm)
395 lbs. (179 kg.) Shipping Weight

45 88
50 108
50 108
50 108
50 108

SCU2070AL
5 Drawers
76 Compartments
Usable Drawer Heights
6-1/4 in. (159 mm)
7 in. (178 mm)
360 lbs. (163 kg.) Shipping Weight



35 68
35 68
35 68
35 68
35 68
35 68
35 68

SCU2041AL
7 Drawers
140 Compartments
Usable Drawer Height
4-5/8 in. (117 mm)
415 lbs. (188 kg.) Shipping Weight

35 58
35 68
35 68
35 88
35 88
35 108
35 108

SEP2041AL
7 Drawers
120 Compartments
Usable Drawer Height
4-5/8 in. (117 mm)
417 lbs. (189 kg.) Shipping Weight

20 58
25 68
35 68
35 88
40 88
70 168

SEP2058AL
7 Drawers
120 Compartments
Usable Drawer Heights
2-1/4 in. (57 mm)
3 in. (76 mm)
4-5/8 in. (117 mm)
5-3/8 in. (137 mm)
10-1/8 in. (257 mm)
420 lbs. (191 kg.) Shipping Weight

45 88
50 108
60 108
90 168

SCU2076AL
4 Drawers
48 Compartments
Usable Drawer Heights
6-1/4 in. (159 mm)
7 in. (178 mm)
8-1/2 in. (216 mm)
13-1/4 in. (337 mm)
326 lbs. (148 kg.) Shipping Weight

45 88
50 108
60 168
90 168

SEP2076AL
4 Drawers
44 Compartments
Usable Drawer Heights
6-1/4 in. (159 mm)
7 in. (178 mm)
8-1/2 in. (216 mm)
13-1/4 in. (337 mm)
330 lbs. (150 kg.) Shipping Weight

75 168
80 168
90 168

SCU2079AL
3 Drawers
27 Compartments
Usable Drawer Heights
10-7/8 in. (276 mm)
11-3/4 in. (9318 mm)
13-1/4 in. (337 mm)
282 lbs. (128 kg.) Shipping Weight

75 168
80 168
90 3232

SEP2079AL
3 Drawers
17 Compartments
Usable Drawer Heights
10-7/8 in. (276 mm)
11-3/4 in. (9318 mm)
13-1/4 in. (337 mm)
285 lbs. (129 kg.) Shipping Weight



20 58
20 58
20 58
20 58
20 68
30 68
40 88

SCU1904AL
8 Drawers
176 Compartments
Usable Drawer Heights
2-1/4 in. (57 mm)
3-7/8 in. (98 mm)
5-3/8 in. (137 mm)
440 lbs. (200 kg.) Shipping Weight

20 58
20 58
20 58
20 58
30 68
40 88
50 108

SCU1905AL
7 Drawers
144 Compartments
Usable Drawer Heights
2-1/4 in. (57 mm)
3-7/8 in. (98 mm)
5-3/8 in. (137 mm)
7 in. (178 mm)
387 lbs. (176 kg.) Shipping Weight

20 48
20 58
20 68
20 88
30 68
40 88
50 108

SEP1905AL
7 Drawers
140 Compartments
Usable Drawer Heights
2-1/4 in. (57 mm)
3-7/8 in. (98 mm)
5-3/8 in. (137 mm)
7 in. (178 mm)
387 lbs. (176 kg.) Shipping Weight



25 48
25 58
25 58
25 68
25 68
25 88
25 88

SEP1001AL
7 Drawers
152 Compartments
Usable Drawer Height
3 in. (76 mm)
388 lbs. (176 kg.) Shipping Weight

20 48
20 58
20 68
20 88
30 68
30 88
35 108

SEP1002AL
7 Drawers
140 Compartments
Usable Drawer Heights
2-1/4 in. (57 mm)
3-7/8 in. (98 mm)
4-5/8 in. (117 mm)
392 lbs. (178 kg.) Shipping Weight

20 58
20 68
20 68
20 68
30 88
30 88
50 108

SEP1004AL
6 Drawers
108 Compartments
Usable Drawer Heights
2-1/4 in. (57 mm)
3 in. (76 mm)
3-7/8 in. (98 mm)
7 in. (178 mm)
361 lbs. (164 kg.) Shipping Weight

STAND-UP HEIGHT

Model 200
37 in. (940 mm) high
30 in. (762 mm) wide
27-3/4 in. (705 mm) deep

To order cabinets without locks, delete the "L" suffix from the model number (example: SEP3014AL becomes SEP3014A).

30 58
30 58
30 58
40 58
40 58

SCU1910AL
6 Drawers
144 Compartments
Usable Drawer Heights
3-7/8 in. (98 mm)
5-3/8 in. (137 mm)
379 lbs. (172 kg.) Shipping Weight

40 88
40 88
40 88
40 88
40 88

SCU1915AL
5 Drawers
80 Compartments
Usable Drawer Height
5-3/8 in. (137 mm)
339 lbs. (154 kg.) Shipping Weight

20 58
30 68
40 88
50 108
60 108

SCU1917AL
5 Drawers
84 Compartments
Usable Drawer Heights
2-1/4 in. (57 mm)
3-7/8 in. (98 mm)
5-3/8 in. (137 mm)
7 in. (178 mm)
8-1/2 in. (216 mm)
335 lbs. (152 kg.) Shipping Weight

BENCH AND WORKSTATION HEIGHT

Model 175
33 in. (838 mm) high
30 in. (762 mm) wide
27-3/4 in. (705 mm) deep

To order cabinets without locks, delete the "L" suffix from the model number (example: SEP3014AL becomes SEP3014A).

20 58
20 58
25 58
30 68
30 68
50 108

SCU1004AL
6 Drawers
124 Compartments
Usable Drawer Heights
2-1/4 in. (57 mm)
3 in. (76 mm)
3-7/8 in. (98 mm)
7 in. (178 mm)
385 lbs. (175 kg.) Shipping Weight

25 58
25 68
30 68
45 88
50 108

SEP1016AL
5 Drawers
92 Compartments
Usable Drawer Heights
3 in. (76 mm)
3-7/8 in. (98 mm)
6-1/4 in. (159 mm)
7 in. (178 mm)
333 lbs. (151 kg.) Shipping Weight

20 58
20 68
40 88
45 108
50 108

SEP1019AL
5 Drawers
84 Compartments
Usable Drawer Heights
2-1/4 in. (57 mm)
3-7/8 in. (98 mm)
6-1/4 in. (159 mm)
7 in. (178 mm)
333 lbs. (151 kg.) Shipping Weight

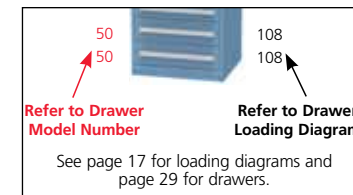
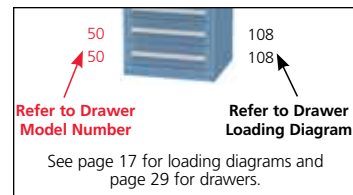

20 58
30 68
30 68
40 88
80 168

SCU1918AL
5 Drawers
88 Compartments
Usable Drawer Heights
2-1/4 in. (57 mm)
3-7/8 in. (98 mm)
5-3/8 in. (137 mm)
11-3/4 in. (292 mm)
330 lbs. (150 kg.) Shipping Weight

50 108
50 108
50 108
50 108

SCU1920AL
4 Drawers
48 Compartments
Usable Drawer Height
7 in. (178 mm)
309 lbs. (140 kg.) Shipping Weight

20 58
25 58

SCU1927AL
2 Drawers
48 Compartments
Usable Drawer Heights
2-1/4 in. (57 mm)
3 in. (76 mm)
245 lbs. (111 kg.) Shipping Weight

20 58
25 68
30 68
40 88
60 108

SEP1023AL
5 Drawers
92 Compartments
Usable Drawer Heights
2-1/4 in. (57 mm)
3 in. (76 mm)
3-7/8 in. (98 mm)
5-3/8 in. (137 mm)
8-1/2 in. (216 mm)
334 lbs. (152 kg.) Shipping Weight

30 68
30 68
40 88
45 88

SCU1012AL
5 Drawers
92 Compartments
Usable Drawer Heights
3-7/8 in. (98 mm)
5-3/8 in. (137 mm)
6-1/4 in. (159 mm)
330 lbs. (150 kg.) Shipping Weight

20 58
25 68
30 68
40 88
60 108

SCU1023AL
5 Drawers
96 Compartments
Usable Drawer Heights
2-1/4 in. (57 mm)
3 in. (76 mm)
3-7/8 in. (98 mm)
5-3/8 in. (137 mm)
8-1/2 in. (216 mm)
330 lbs. (150 kg.) Shipping Weight



SCU1010AL
5 Drawers
100 Compartments
Usable Drawer Height
4-5/8 in (117 mm)
313 lbs. (142 kg.) Shipping Weight



SEP1031AL
4 Drawers
56 Compartments
Usable Drawer Heights
5-3/8 in. (137 mm)
6-1/4 in. (159 mm)
304 lbs. (138 kg.) Shipping Weight



SCU1043AL
3 Drawers
36 Compartments
Usable Drawer Heights
6-1/4 in. (159 mm)
8-1/2 in. (216 mm)
10-1/8 in. (257 mm)
267 lbs. (121 kg.) Shipping Weight



SEP1401AL
6 Drawers
136 Compartments
Usable Drawer Heights
3 in (76mm)
3-7/8 in (98mm)
295 lbs (133 kg) Shipping Weight



SEP1402AL
6 Drawers
132 Compartments
Usable Drawer Heights
2-1/4 in (57mm)
3 in (76mm)
6-1/4 in (259 mm)
298 lbs (135 kg) Shipping Weight



SEP1411AL
3 Drawers
40 Compartments
Usable Drawer Heights
4-5/8 in (117 mm)
8-1/2 in (216 mm)
219 lbs (99 kg) Shipping Weight



SCU1072AL
3 Drawers
40 Compartments
Usable Drawer Heights
2-1/4 in. (57 mm)
10-7/8 in. (276 mm)
11-3/4 in. (318 mm)
258 lbs. (117 kg.) Shipping Weight



SEP1045AL
2 Drawers
16 Compartments
Usable Drawer Heights
12-1/2 in. (318 mm)
13-1/4 in. (337 mm)
231 lbs. (105 kg.) Shipping Weight



SD175LH1
Left hinge
SD175RH1
Right hinge
2 Shelves
186 lbs. (84 kg.) Shipping Weight

BENCH AND WORKSTATION HEIGHT

Model 155
30 in (762 mm) high
30 in (762 mm) wide
27-3/4 in (705 mm) deep

To order cabinets without locks, delete the "L" suffix from the model number (example: SEP3014AL becomes SEP3014A).

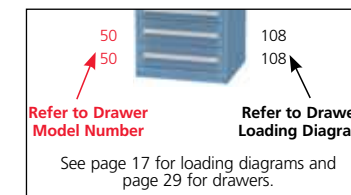

SEP1405AL
4 Drawers
68 Compartments
Usable Drawer Heights
2-1/4 in (57 mm)
3-7/8 in (98 mm)
4-5/8 in (117 mm)
10-1/8 in (257 mm)
246 lbs (111 kg) Shipping Weight



SEP1404AL
4 Drawers
56 Compartments
Usable Drawer Heights
4-5/8 in (117 mm)
5-3/8 in (137 mm)
255 lbs (115 kg) Shipping Weight



SEP1406AL
3 Drawers
28 Compartments
Usable Drawer Heights
7 in (178 mm)
7-3/4 in (197 mm)
219 lbs (99 kg) Shipping Weight



SEP1407AL
2 Drawers
16 Compartments
Usable Drawer Heights
10-7/8 in (276 mm)
11-3/4 in (318 mm)
184 lbs (83kg) Shipping Weight





SCU1701AL
5 Drawers
112 Compartments
Usable Drawer Heights
3 in (76 mm)
3-7/8 in (98 mm)
265 lbs (120 kg) Shipping Weight



SCU1702AL
3 Drawers
80 Compartments
Usable Drawer Heights
3-7/8 in (98 mm)
4-5/8 in (117 mm)
244 lbs (110kg) Shipping Weight



SCU1705AL
3 Drawers
48 Compartments
Usable Drawer Heights
3-7/8 in (98 mm)
10-7/8 in (276 mm)
212 lbs (96 kg) Shipping Weight

BENCH AND WORKSTATION HEIGHT

Model 135
27 in (686 mm) high
30 in (762 mm) wide
27-3/4 in (705 mm) deep

To order cabinets without locks, delete the "L" suffix from the model number (example: SEP3014AL becomes SEP3014A).



SCU1704AL
3 Drawers
48 Compartments
Usable Drawer Heights
2-1/4 in (57mm)
7 in (178 mm)
10-1/8 in (257 mm)
209 lbs (94 kg) Shipping Weights



SCU1703AL
3 Drawers
48 Compartments
Usable Drawer Heights
6-1/4 in (159 mm)
217 lbs (98 kg) Shipping Weight



SCU1707AL
2 Drawers
16 Compartments
Usable Drawer Heights
9-3/8 in (235 mm)
10-1/8 in (257 mm)
178 lbs (80 kg) Shipping Weight

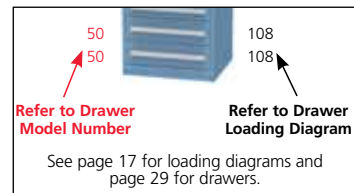

DRAWER INTERIORS FOR PRECONFIGURED CABINETS

Standard Loading Diagrams
• 28 proven drawer interiors



LD3232
1 Compartment
25-1/8 in. x 25-1/8 in.
(638 mm x 638 mm)



LD46
40 Compartments
2-5/8 in. x 4-5/8 in.
(67 mm x 117 mm)



LD510
18 Compartments
3-1/2 in. x 7-7/8 in.
(89 mm x 200 mm)



LD516
12 Compartments
3-1/2 in. x 12-1/2 in.
(89 mm x 318 mm)



LD48
32 Compartments
25/8 in. x 6-1/8 in.
(67 mm x 156 mm)



LD54
48 Compartments
3-1/2 in. x 2-7/8 in.
(89 mm x 73 mm)



LD56
30 Compartments
3-1/2 in. x 4-5/8 in.
(89 mm x 117 mm)



LD58
24 Compartments
3-1/2 in. x 6-1/8 in.
(89 mm x 156 mm)



LD65
30 Compartments
4-1/4 in. x 3-7/8 in.
(108 mm x 98 mm)



LD66
25 Compartments
4-1/4 in. x 4-5/8 in.
(108 mm x 117 mm)



LD68
20 Compartments
4-1/4 in. x 6-1/8 in.
(108 mm x 156 mm)



LD610
15 Compartments
4-1/4 in. x 7-7/8 in.
(108 mm x 200 mm)



BN-48
48 Bins
(32) 3 in. x 3 in.
(76 mm x 76 mm)
(16) 3 in. x 6-1/8 in.
(76 mm x 156 mm)



LD168
8 Compartments
12-1/4 in. x 6-1/8 in.
(311 mm x 156 mm)



LD86
20 Compartments
5-7/8 in. x 4-5/8 in.
(149 mm x 117 mm)



LD88
16 Compartments
5-7/8 in. x 6-1/8 in.
(149 mm x 156 mm)



LD810
12 Compartments
5-7/8 in. x 7-7/8 in.
(149 mm x 200 mm)



LD816
8 Compartments
5-7/8 in. x 12-1/2 in.
(149 mm x 318 mm)



LD84
32 Compartments
5-7/8 in. x 2-7/8 in.
(149 mm x 73 mm)



LD85
24 Compartments
5-7/8 in. x 3-7/8 in.
(149 mm x 98 mm)



LD1016
6 Compartments
7-1/2 in. x 12-1/2 in.
(191 mm x 318 mm)



LD1610
6 Compartments
12-1/4 in. x 7-7/8 in.
(311 mm x 200 mm)



BN-12 12 Bins:
(4) 6-1/8 in. x 12 in.
(156 mm x 305 mm)
(8) 6-1/8 in. x 6-1/8 in.
(156 mm x 156 mm)



BN-16 16 Bins:
(16) 6-1/8 in. x 6-1/8 in.
(156 mm x 156 mm)



LD108
12 Compartments
7-1/2 in. x 6-1/8 in.
(191 mm x 156 mm)



LD1010
9 Compartments
7-1/2 in. x 7-7/8 in.
(191 mm x 200 mm)



BN-24 24 Bins:
(8) 6-1/8 in. x 6-1/8 in.
(156 mm x 156 mm)
(16) 3 in. x 6-1/8 in.
(76 mm x 156 mm)



BN-32 32 Bins:
(32) 3 in. x 6-1/8 in.
(76 mm x 156 mm)



BN-64 64 Bins:
(64) 3 in. x 3 in.
(76 mm x 76 mm)



PS70
2 Hanging File
Compartments
12-1/4 in. x 25-1/8 in.
(311 mm x 638 mm)



RP1144AL
33 in. (838 mm) High
7 Drawers
105 Compartments
Usable Drawer Height
3 in. (76 mm)
306 lbs. (139 kg.) Shipping Weight



RP1145AL
33 in. (838 mm) High
6 Drawers
90 Compartments
Usable Drawer Heights
2-1/4 in. (57 mm)
3 in. (76 mm)
3-7/8 in. (98 mm)
7 in. (178 mm)
290 lbs. (135 kg.) Shipping Weight



RP1138AL
33 in. (838 mm) High
5 Drawers
72 Compartments
Usable Drawer Heights
2-1/4 in. (57 mm)
3 in. (76 mm)
3-7/8 in. (98 mm)
5-3/8 in. (137 mm)
8-1/2 in. (216 mm)
266 lbs. (121 kg.) Shipping Weight

SHALLOW DEPTH

30 in. (762 mm) wide
21-3/8 in. (543 mm) deep
Available in all standard heights

To order cabinets without locks, delete the "L" suffix from the model number (example: SEP3014AL becomes SEP3014A).



RP1941AL
37 in. (940 mm) High
8 Drawers
132 Compartments
Usable Drawer Heights
2-1/4 in. (57 mm)
3-7/8 in. (98 mm)
5-3/8 in. (137 mm)
432 lbs. (196 kg.) Shipping Weight



RP1942AL
37 in. (940 mm) High
6 Drawers
87 Compartments
Usable Drawer Heights
2-1/4 in. (57 mm)
3-7/8 in. (98 mm)
5-3/8 in. (137 mm)
8-1/2 in. (216 mm)
377 lbs. (171 kg.) Shipping Weight



RP2144AL
44 in. (1118 mm) High
7 Drawers
89 Compartments
Usable Drawer Heights
2-1/4 in. (57 mm)
3 in. (76 mm)
3-7/8 in. (98 mm)
5-3/8 in. (137 mm)
7 in. (178 mm)
334 lbs. (152 kg.) Shipping Weight

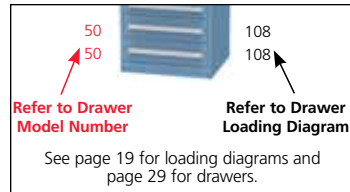

RP2145AL
44 in. (1118 mm) High
6 Drawers
72 Compartments
Usable Drawer Heights
3-7/8 in. (98 mm)
4-5/8 in. (117 mm)
5-3/8 in. (137 mm)
7 in. (178 mm)
320 lbs. (145 kg.) Shipping Weight



RP3504AL
59 in. (1499 mm) High
9 Drawers
117 Compartments
Usable Drawer Heights
3-7/8 in. (98 mm)
5-3/8 in. (137 mm)
8-1/2 in. (216 mm)
440 lbs. (200 kg.) Shipping Weight



RP3503AL
59 in. (1499 mm) High
5 Drawers
42 Compartments
Usable Drawer Heights
7 in. (178 mm)
8-1/2 in. (216 mm)
10-1/8 in. (257 mm)
13-1/4 in. (337 mm)
323 lbs. (147 kg.) Shipping Weight

DRAWER INTERIORS FOR PRECONFIGURED SHALLOW DEPTH CABINETS

Shallow Depth Loading Diagrams



LDLW46
32 Compartments
2-5/8 in. x 4-1/2 in.
(67 mm x 114 mm)



LDLW56
24 Compartments
3-1/2 in. x 4-1/2 in.
(89 mm x 114 mm)



LDLW58
18 Compartments
3-1/2 in. x 6-1/8 in.
(89 mm x 156 mm)



LDLW512
12 Compartments
3-1/2 in. x 9-1/4 in.
(89 mm x 235 mm)



LDLW64
30 Compartments
4-1/2 in. x 2-7/8 in.
(114 mm x 73 mm)



LDLW66
20 Compartments
4-1/4 in. x 4-1/2 in.
(108 mm x 114 mm)



LDLW68
15 Compartments
4-1/4 in. x 6-1/8 in.
(108 mm x 156 mm)



LDLW612
10 Compartments
4-1/4 in. x 9-1/4 in.
(108 mm x 235 mm)



LDLW84
24 Compartments
5-7/8 in. x 2-7/8 in.
(149 mm x 73 mm)



LDLW86
16 Compartments
5-7/8 in. x 4-1/2 in.
(149 mm x 114 mm)



LDLW88
12 Compartments
5-7/8 in. x 6-1/8 in.
(149 mm x 156 mm)



LDLW812
8 Compartments
5-7/8 in. x 9-1/4 in.
(149 mm x 235 mm)



LDLW106
12 Compartments
7-1/2 in. x 4-1/2 in.
(191 mm x 114 mm)



LDLW108
9 Compartments
7-1/2 in. x 6-1/8 in.
(191 mm x 156 mm)



LDLW1012
6 Compartments
7-1/2 in. x 9-1/4 in.
(191 mm x 235 mm)



LDLW166
8 Compartments
12-1/2 in. x 4-1/2 in.
(318 mm x 114 mm)



LDLW168
6 Compartments
12-1/2 in. x 6-1/8 in.
(318 mm x 156 mm)



LDLW1612
4 Compartments
12-1/2 in. x 9-1/4 in.
(318 mm x 235 mm)



LDLW68L
24 Compartments
4-1/4 in. x 6-1/8 in.
(108 mm x 156 mm)



LDLW84L
24 Compartments
5-7/8 in. x 2-7/8 in.
(149 mm x 73 mm)



LDLW88L
12 Compartments
5-7/8 in. x 6-1/8 in.
(149 mm x 156 mm)



RP1135AL
33 in. (838 mm) High
Usable Drawer Height
3 in. (76 mm)
322 lbs. (146 kg.) Shipping Weight

RP1134AL
33 in. (838 mm) High
6 Drawers
88 Compartments
Usable Drawer Heights
2-1/4 in. (57 mm)
3 in. (76 mm)
3-7/8 in. (98 mm)
7 in. (178 mm)
304 lbs. (138 kg.) Shipping Weight

RP1136AL
33 in. (838 mm) High
5 Drawers
68 Compartments
Usable Drawer Heights
2-1/4 in. (57 mm)
3 in. (76 mm)
3-7/8 in. (98 mm)
5-3/8 in. (137 mm)
8-1/2 in. (216 mm)
279 lbs. (127 kg.) Shipping Weight

SMALL VERSION

22-1/2 in. (572 mm) wide
27-3/4 in. (705 mm) deep
Available in all standard heights.

To order cabinets without locks, delete the "L" suffix from the model number (example: SEP3014AL becomes SEP3014A).

RP1940AL
37 in. (940 mm) High
7 Drawers
100 Compartments
Usable Drawer Heights
2-1/4 in. (57 mm)
3-7/8 in. (98 mm)
5-3/8 in. (137 mm)
7 in. (178 mm)
343 lbs. (156 kg.) Shipping Weight

RP1939AL
37 in. (940 mm) High
6 Drawers
96 Compartments
Usable Drawer Heights
3-7/8 in. (98 mm)
5-3/8 in. (137 mm)
7 in. (178 mm)
323 lbs. (147 kg.) Shipping Weight

RP2143AL
44 in. (1118 mm) High
6 Drawers
72 Compartments
Usable Drawer Heights
3-7/8 in. (98 mm)
4-5/8 in. (117 mm)
5-3/8 in. (137 mm)
7 in. (178 mm)
339 lbs. (154 kg.) Shipping Weight

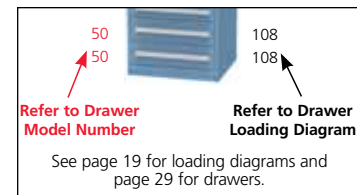

RP3501AL
59 in. (1499 mm) High
9 Drawers
120 Compartments
Usable Drawer Heights
3-7/8 in. (98 mm)
5-3/8 in. (137 mm)
8-1/2 in. (216 mm)
461 lbs. (209 kg.) Shipping Weight

RP3500AL
59 in. (1499 mm) High
8 Drawers
88 Compartments
Usable Drawer Heights
5-3/8 in. (137 mm)
7 in. (178 mm)
432 lbs. (196 kg.) Shipping Weight

RP3502AL
59 in. (1499 mm) High
7 Drawers
60 Compartments
Usable Drawer Heights
5-3/8 in. (137 mm)
7 in. (178 mm)
400 lbs. (181 kg.) Shipping Weight



DRAWER INTERIORS FOR PRECONFIGURED SMALL VERSION CABINETS

Small Version Loading Diagrams



LDSV54
32 Compartments
3-1/2 in. x 2-7/8 in.
(89 mm x 73 mm)

LDSV56
20 Compartments
3-1/2 in. x 4-5/8 in.
(89 mm x 117 mm)

LDSV58
16 Compartments
3-1/2 in. x 6-1/8 in.
(89 mm x 156 mm)

LDSV510
12 Compartments
3-1/2 in. x 7-7/8 in.
(89 mm x 200 mm)

LDSV532
4 Compartments
3 1/2 in. x 25 1/8 in.
(89 mm x 638 mm)

LDSV74
24 Compartments
5-1/8 in. x 2-7/8 in.
(130 mm x 73 mm)

LDSV76
15 Compartments
5-1/8 in. x 4-5/8 in.
(130 mm x 117 mm)

LDSV78
12 Compartments
5-1/8 in. x 6-1/8 in.
(130 mm x 156 mm)

LDSV710
9 Compartments
5-1/8 in. x 7-7/8 in.
(130 mm x 200 mm)

LDSV732
3 Compartments
5-1/8 in. x 25-1/8 in.
(130 mm x 638 mm)

LDSV114
16 Compartments
8-1/4 in. x 2-7/8 in.
(210 mm x 73 mm)

LDSV116
10 Compartments
8-1/4 in. x 4-5/8 in.
(210 mm x 117 mm)

LDSV118
8 Compartments
8-1/4 in. x 6-1/8 in.
(210 mm x 156 mm)

LDSV1116
4 Compartments
8-1/4 in. x 12-1/2 in.
(210 mm x 318 mm)

LDSV1132
2 Compartments
8-1/4 in. x 25-1/8 in.
(210 mm x 638 mm)



20
20
25
30
30
50



RP1147AL
33 in. (838 mm) High
6 Drawers
204 Compartments
Usable Drawer Heights
2-1/4 in. (57 mm)
3 in. (76 mm)
3-7/8 in. (98 mm)
7 in. (178 mm)
527 lbs. (239 kg.) Shipping Weight

20
25
30
40
60



RP1146AL
33 in. (838 mm) High
5 Drawers
156 Compartments
Usable Drawer Heights
2-1/4 in. (57 mm)
3 in. (76 mm)
3-7/8 in. (98 mm)
5-3/8 in. (137 mm)
8-1/2 in. (216 mm)
483 lbs. (219 kg.) Shipping Weight



RP1943AL
37 in. (940 mm) High
2 Drawers
1 Bottom Pan
64 Compartments
Usable Drawer Heights
3-7/8 in. (98 mm)
4-5/8 in. (117 mm)
366 lbs. (166 kg.) Shipping Weight

EXTRA-WIDE

45 in. (1143 mm) wide
27-3/4 in. (705 mm) deep
Available in all standard heights.

To order cabinets without locks, delete the "L" suffix from the model number (example: SEP3014AL becomes SEP3014A).

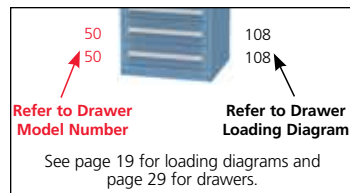

30
35
40
40
50
50



RP2147AL
44 in. (1118 mm) High
6 Drawers
152 Compartments
Usable Drawer Heights
3-7/8 in. (98 mm)
4-5/8 in. (117 mm)
5-3/8 in. (137 mm)
7 in. (178 mm)
579 lbs. (263 kg.) Shipping Weight

25
40
40
50
80



RP2146AL
44 in. (1118 mm) High
5 Drawers
140 Compartments
Usable Drawer Heights
3 in. (76 mm)
5-3/8 in. (137 mm)
7 in. (178 mm)
11-3/4 in. (292 mm)
531 lbs. (241 kg.) Shipping Weight



RP3505AL
59 in. (1499 mm) High
11 Drawers
371 Compartments
Usable Drawer Heights
2-1/4 in. (57 mm)
3-7/8 in. (98 mm)
5-3/8 in. (137 mm)
7 in. (178 mm)
866 lbs. (393 kg.) Shipping Weight

30
30
30
30
40
40
40
40
60



RP3506AL
59 in. (1499 mm) High
9 Drawers
244 Compartments
Usable Drawer Heights
3-7/8 in. (98 mm)
5-3/8 in. (137 mm)
8-1/2 in. (216 mm)
797 lbs. (362 kg.) Shipping Weight

80
20
80
80
80
80



RP3507AL
59 in. (1499 mm) High
4 Drawers
1 Roll out XWRS20
8 Compartments
Usable Drawer Heights
2-1/4 in. (57 mm)
11-3/4 in. (292 mm)
492 lbs. (223 kg.) Shipping Weight

50
60
70
70
90



RP3508AL
59 in. (1499 mm) High
5 Drawers
88 Compartments
Usable Drawer Heights
7 in. (178 mm)
8-1/2 in. (216 mm)
10-1/8 in. (257 mm)
13-1/4 in. (337 mm)
578 lbs. (262 kg.) Shipping Weight



DRAWER INTERIORS FOR PRECONFIGURED EXTRA-WIDE CABINETS

Extra-Wide Loading Diagrams

An "L" suffix added to the end of a loading diagram model number indicates that the partitions run left to right.



LDXW46
60 Compartments
2-5/8 in. x 4-5/8 in.
(67 mm x 117 mm)



LDXW48
48 Compartments
2-5/8 in. x 6-1/8 in.
(67 mm x 156 mm)



LDXWPS70
3 Hanging File Compartments
12-1/4 in. 18-3/4 in.
(311 mm x 476 mm)



LDXW58
40 Compartments
3-1/2 in. x 6-1/8 in.
(89 mm x 156 mm)



LDXW68
32 Compartments
4-1/4 in. x 6-1/8 in.
(108 mm x 156 mm)



LDXW128
16 Compartments
9 in. x 6-1/8 in.
(228 mm x 156 mm)



LDXW84
48 Compartments
5-7/8 in. x 2-7/8 in.
(149 mm x 73 mm)



LDXW88
24 Compartments
5-7/8 in. x 6-1/8 in.
(149 mm x 156 mm)



LDXW816
12 Compartments
5-7/8 in. x 12-1/2 in.
(149 mm x 318 mm)



LDXW108
20 Compartments
7-1/2 in. x 6-1/8 in.
(191 mm x 156 mm)



LDXW1010
15 Compartments
7-1/2 in. x 7-7/8 in.
(191 mm x 200 mm)



LDXW1016
10 Compartments
7-1/2 in. x 12-1/2 in.
(191 mm x 318 mm)



LDXW46L
64 Compartments
2-5/8 in. x 4-5/8 in.
(67 mm x 117 mm)



LDXW451L
8 Compartments
2-5/8 in. x 40-1/4 in.
(67 mm x 1022 mm)



LDXW48L
48 Compartments
2-5/8 in. x 6-1/4 in.
(67 mm x 159 mm)



LDXW551L
6 Compartments
3-1/2 in. x 40-1/4 in.
(89 mm x 1022 mm)



LDXW58L
36 Compartments
3-1/2 in. x 6-1/4 in.
(89 mm x 159 mm)



LDXW651L
5 Compartments
4-1/4 in. x 40-1/4 in.
(108 mm x 1022 mm)



LDXW68L
30 Compartments
4-1/4 in. x 6-1/4 in.
(108 mm x 159 mm)



LDXW84L
48 Compartments
5-7/8 in. x 3 in.
(149 mm x 76 mm)



LDXW851L
4 Compartments
5-7/8 in. x 40-1/4 in.
(149 mm x 1022 mm)



LDXW88L
24 Compartments
5-7/8 in. x 6-1/4 in.
(149 mm x 159 mm)



LDXW1010L
15 Compartments
7-1/2 in. x 7-5/8 in.
(191 mm x 194 mm)



LDXW1051L
3 Compartments
7-1/2 in. x 40-1/4 in.
(191 mm x 1022 mm)



LDXW108L
18 Compartments
7-1/2 in. x 6-1/4 in.
(191 mm x 159 mm)



LDXW1651L
2 Compartments
12-1/2 in. x 40-1/4 in.
(318 mm x 1022 mm)



RP1148AL
33 in. (838 mm) High
6 Drawers
284 Compartments
Usable Drawer Heights
2-1/4 in. (57 mm)
3 in. (76 mm)
3-7/8 in. (98 mm)
7 in. (178 mm)
666 lbs. (302 kg.) Shipping Weight



RP1149AL
33 in. (838 mm) High
5 Drawers
224 Compartments
Usable Drawer Heights
2-1/4 in. (57 mm)
3 in. (76 mm)
3-7/8 in. (98 mm)
5-3/8 in. (137 mm)
8-1/2 in. (216 mm)
621 lbs. (282 kg.) Shipping Weight



RP1944AL
37 in. (940 mm) High
6 Drawers
268 Compartments
Usable Drawer Heights
2-1/4 in. (57 mm)
3-7/8 in. (98 mm)
5-3/8 in. (137 mm)
8-1/2 in. (216 mm)
694 lbs. (315 kg.) Shipping Weight

DOUBLE-WIDE

60 in. (1524 mm) wide
27-3/4 in. (705 mm) deep
Available in all standard heights.

To order cabinets without locks, delete the "L" suffix from the model number (example: SEP3014AL becomes SEP3014A).



RP2148AL
44 in. (1118 mm) High
6 Drawers
224 Compartments
Usable Drawer Heights
3-7/8 in. (98 mm)
4-5/8 in. (117 mm)
5-3/8 in. (137 mm)
7 in. (178 mm)
747 lbs. (339 kg.) Shipping Weight



RP2149AL
44 in. (1118 mm) High
12 Drawers
24 Compartments
Usable Drawer Heights
2-1/4 in. (57 mm)
3 in. (76 mm)
905 lbs. (411 kg.) Shipping Weight



RP3511AL
59 in. (1499 mm) High
9 Drawers
364 Compartments
Usable Drawer Heights
3-7/8 in. (98 mm)
5-3/8 in. (137 mm)
8-1/2 in. (216 mm)
989 lbs. (449 kg.) Shipping Weight

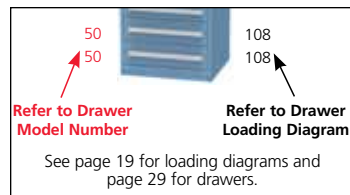

RP3510AL
59 in. (1499 mm) High
5 Drawers
86 Compartments
Usable Drawer Heights
7 in. (178 mm)
8-1/2 in. (216 mm)
10-1/8 in. (257 mm)
13-1/4 in. (337 mm)
725 lbs. (329 kg.) Shipping Weight



RP3512AL
59 in. (1499 mm) High
7 Drawers
208 Compartments
Usable Drawer Heights
5-3/8 in. (137 mm)
7 in. (178 mm)
893 lbs. (405 kg.) Shipping Weight



RP3509AL
59 in. (1499 mm) High
6 Drawers
144 Compartments
Usable Drawer Heights
6-1/4 in. (159 mm)
7 in. (178 mm)
8-1/2 in. (216 mm)
11-3/4 in. (292 mm)
797 lbs. (362 kg.) Shipping Weight



DRAWER INTERIORS FOR PRECONFIGURED DOUBLE-WIDE CABINETS

Double-Wide Loading Diagrams

An "L" suffix added to the end of a loading diagram model number indicates that the partitions run left to right.



LDDW58
56 Compartments
3-1/2 in. x 6-1/8 in.
(89 mm x 156 mm)



LDDW68
44 Compartments
4-1/4 in. x 6-1/8 in.
(108 mm x 156 mm)



LDDW78
40 Compartments
5-1/8 in. x 6-1/8 in.
(130 mm x 156 mm)



LDDW108
28 Compartments
7-1/2 in. x 6-1/8 in.
(191 mm x 156 mm)



LDDW470L
8 Compartments
2-5/8 in. x 55-3/8 in.
(67 mm x 1407 mm)



LDDW570L
6 Compartments
3-1/2 in. x 55-3/8 in.
(89 mm x 1047 mm)



LDDW670L
5 Compartments
4-1/4 in. x 55-3/8 in.
(108 mm x 1047 mm)



LDDW870L
4 Compartments
5-7/8 in. x 55-3/8 in.
(149 mm x 1047 mm)



LDDW1070L
3 Compartments
7-1/2 in. x 55-3/8 in.
(191 mm x 1047 mm)



LDDW1670L
2 Compartments
12-1/4 in. x 55-3/8 in.
(311 mm x 1047 mm)



RP1171AL
 33 in. (838 mm) High
 6 Drawers
 153 Compartments
 Usable Drawer Heights
 2-1/4 in. (57 mm)
 3 in. (76 mm)
 3-7/8 in. (98 mm)
 7 in. (178 mm)
 377 lbs. (171 kg.) Shipping Weight



RP2151AL
 44 in. (1118 mm) High
 6 Drawers
 114 Compartments
 Usable Drawer Heights
 3-7/8 in. (98 mm)
 4-5/8 in. (117 mm)
 5-3/8 in. (137 mm)
 7 in. (178 mm)
 430 lbs. (195 kg.) Shipping Weight



RP3520AL
 59 in. (1499 mm) High
 9 Drawers
 183 Compartments
 Usable Drawer Heights
 3-7/8 in. (98 mm)
 5-3/8 in. (137 mm)
 8-1/2 in. (216 mm)
 637 lbs. (289 kg.) Shipping Weight



RP3521AL
 59 in. (1499 mm) High
 5 Drawers
 66 Compartments
 Usable Drawer Heights
 7 in. (178 mm)
 8-1/2 in. (216 mm)
 10-1/8 in. (257 mm)
 13-1/4 in. (337 mm)
 428 lbs. (194 kg.) Shipping Weight

EXTRA-WIDE SHALLOW DEPTH

45 in. (1143 mm) wide
 21-3/8 in. (543 mm) deep

To order cabinets without locks, delete the "L" suffix from the model number (example: SEP3014AL becomes SEP3014A).

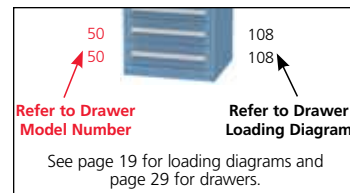

DRAWER INTERIORS FOR PRECONFIGURED EXTRA-WIDE SHALLOW DEPTH CABINETS

Extra-Wide Shallow Depth Loading Diagrams



LDXL58
 30 Compartments
 (27) 3-1/2 in. x 6-1/8 in.
 (89 mm x 156 mm)
 (3) 4-1/4 in. x 6-1/8 in.
 (108 mm x 156 mm)



LDXL68
 24 Compartments
 4-1/4 in. x 6-1/8 in.
 (108 mm x 156 mm)



LDXL88
 18 Compartments
 5-7/8 in. x 6-1/8 in.
 (149 mm x 156 mm)



LDXL108
 15 Compartments
 7-1/2 in. x 6-1/8 in.
 (191 mm x 156 mm)



LDXL128
 12 Compartments
 9 in. x 4-5/8 in.
 (229 mm x 118 mm)



Parts Storage











Issue Counter



Cabinets

1. SELECT HOUSING FOOTPRINT:

For example: ST = 30" W x 27-3/4" D

<p>Standard - ST</p>  <p>27-3/4" D</p> <p>30" W</p>	<p>Small Version - SV</p>  <p>22-1/2" W</p>	<p>Extra-Wide - XW</p>  <p>45" W</p>	<p>Double-Wide - DW</p>  <p>60" W</p>
<p>Shallow Depth - LW</p>  <p>21-3/8" D</p> <p>30" W</p>	<p>Small Version Shallow Depth - SL</p>  <p>22-1/2" W</p>	<p>Extra-Wide Shallow Depth - XL</p>  <p>45" W</p>	<p>Double-Wide Shallow Depth - DL</p>  <p>60" W</p>

2. SELECT HOUSING HEIGHT:

For example: 0340 = 59" H

The complete housing model number is ST0340

 <p>Desk (Model 0135) 27" (686mm)</p>	 <p>Table (Model 0155) 30" (762mm)</p>	 <p>Bench (Model 0175) 33" (838mm)</p>	 <p>Standup Work (Model 0200) 37" (940mm)</p>	 <p>Counter (Model 0245) 44" (1118mm)</p>	 <p>Eye Level (Model 0340) 59" (1499mm)</p>	
---	--	--	---	--	---	---

3. CHOOSE YOUR DRAWERS:

THE DRAWER CAPACITY IS 400 LBS EACH

The drawer model numbers add up to the housing model number, for example:

20	20	 <p>ST340</p>
20	20	
30	30	
30	30	
30	30	
30	50	
50	50	
50	80	
80		
= 340		

- Model 20
- Model 25
- Model 30
- Model 35
- Model 40
- Model 45
- Model 50
- Model 55
- Model 60
- Model 65
- Model 70
- Model 75
- Model 80
- Model 85
- Model 90
- Model 95
- Model 100
- Model 105
- Model 110
- Model 115
- Model 120
- Model 125
- Model 130
- Model 135
- Model 140
- Model 145
- Model 150



STANDARD (STD)	USABLE HEIGHT "C"
20	2-1/4"
25	3
30	3-7/8"
35	4-5/8"
40	5-3/8"
45	6-1/4"
50	7"
55	7-3/4"
60	8-1/2"
65	9-3/8"
70	10-1/8"
75	10-7/8"
80	11-3/4"
85	12-1/2"
90	13-1/4"
95	14-1/4"
100	14-7/8"
105	15-5/8"
110	16-3/8"
115	17-1/4"
120V	18-1/8"
125	18-7/8"
130	19-5/8"
135	20-3/8"
140	21-1/8"
145	21-7/8"
150	22-3/4"

Now you have configured your cabinet. For drawer interiors or accessories go to page 34. For further assistance please contact your local Territory Sales Manager or visit us on the web at STANLEYVidmar.com



Fully Optimized and Organized

MASTER LOCKING SYSTEM

- Create custom locking and access for cabinets and drawers
- Secure as few as one drawer or several cabinets with a single lock



Master Locking System

Cabinet Locks

MODEL #	USED WITH CABINETS
SL10	Standard, Small Version, Extra-Wide, Double-Wide, Standard Under-Bench, Small Version Under-Bench
LWSL10	Shallow Depth, Extra-Wide Shallow Depth, Double-Wide Shallow Depth, Small Version Shallow Depth
NRKF	Non-removable key feature
Key1	Key
Key2	Master key

Provide order in writing for these items.

HINGE LOCK BARS

- Hinge lock, double-action bar must be lifted and swung out of the way to access drawers
- May be secured with a single padlock. (Padlocks not included.)
- Bars provide extra security; use in mobile/shipboard applications
- Hinge lock bars on XW, XL, DL, and DW shelf door cabinets are center-mounted on double doors



Hinge Lock Bar

Hinge Lock Bars

MODEL #	MODEL #	HEIGHT	USED WITH CABINET STYLES
LEFT-HAND	RIGHT-HAND		
HLBL1351	HLBR1351	135	STD, LW, SV, SL, XW, XL, DW, DL
	HLBR1353	135	XW, DW, XL, DL (SD Cabinets Only)
HLBL1551	HLBR1551	155	STD, LW, SV, SL, XW, XL, DW, DL
	HLBR1553	155	XW, DW, XL, DL (SD Cabinets Only)
HLBL1751	HLBR1751	175	STD, LW, SV, SL, XW, XL, DW, DL
	HLBR1753	175	XW, DW, XL, DL (SD Cabinets Only)
HLBL2001	HLBR2001	200	STD, LW, SV, SL, XW, XL, DW, DL
	HLBR2003	200	XW, DW, XL, DL (SD Cabinets Only)
HLBL2451	HLBR2451	245	STD, LW, SV, SL, XW, XL, DW, DL
	HLBR2453	245	XW, DW, XL, DL (SD Cabinets Only)
HLBL3401	HLBR3401	340	STD, LW, SV, SL, XW, DW, XL, DL
	HLBR3403	340	XW, DW, XL, DL (SD Cabinets Only)

KEY PAD LOCK

- Able to program up to 25 different user codes
- Eliminates lost keys
- retrofittable into existing Vidmar drawer cabinets



Key Pad Lock

Key Pad Lock

MODEL #	DESCRIPTION
KPL-STD	Keypad Lock, STD depth
KPL-STD	Keypad Lock, STD depth

SLING PICKUP FEATURE

- The sling pickup feature consists of four threaded steel blocks welded to columns inside the cabinet
- Blocks accept four eye bolts (supplied) so that cabinet can be lifted fully loaded (6,800 lbs.)
- Cabinets should be ordered with lock-in/lock-out latches and be banded when moved



Sling Pickup

SPOOL FEATURE

- Includes a left and right hanging bracket and a spool bar
- Ideal for handling rolls of wire or for hangers



Spool Feature

RECESSED BASES

- Provide additional toe space at work or issue areas 3" (76mm) high



Recessed Bases

Recessed Bases

MODEL #	DESCRIPTION
RB1	One Standard
RB2	Two Standard or One Double-Wide
LWRB1	One Shallow Depth
SVRB1	One Small Version
SVRB2	Two Small Versions
XWRB1	One Extra-Wide or Two Small Versions
XLRB1	One Extra-Wide Shallow Depth
DWRB1	One Double-Wide

KICK PLATES

- Protect outside floor level surfaces of a cabinet
- Kick plates are stainless steel, 7" (178mm) high
- Mounted directly to the cabinet with hardware provided
- Ideal for parts issue or high-traffic areas



Kick Plates

Kick Plates

MODEL #	DESCRIPTION
KP1	One Standard or Shallow Depth
KP2	Two Standard, Shallow Depth, Double-Wide
KP6C	Corner Desk
XWKP1	One Extra-Wide or Extra-Wide Shallow Depth
SVKP1	One Small Version

FOUR-WAY PALLET BASE

- Allows forklift entry from all sides of cabinet
- Cabinets should be banded when moved



Four-Way Pallet Base

Four-Way Pallet Base

MODEL #	FOR USE WITH HOUSINGS
PB4ST	Standard
PB4XW	Extra-Wide
PB4DW	Double-Wide
PB4C	Covers (Two Per Set)
PB4XL	Extra-Wide Shallow Depth
PB4SV	Small Version
PB4LW	Shallow Depth

SECURITY DRAWER AND TOP PANEL

- Individual, key-activated security drawer locks can lock a specific drawer independent of cabinet locks
- Security panels, provided with all security locks except for top drawer, prevent access even when drawer above is removed
- Recommended for personal storage or inventory storage in high-traffic areas
- In XW and DW drawers only, security panel uses an additional five points of space in the housing (ex. a DW40SECL requires an opening of 45 points)
- Security locks are available for drawer models 25 and larger



Security Drawer and Panel

Security Drawer Top Feature

MODEL #	DESCRIPTION
XXSECR	Right-hand side of drawer
XXSECL	Left-hand side of drawer
XXSECRL	Right-hand and left-hand sides of drawer
SECP1	Standard security panel only

Single Drawer Release (Not Pictured)

MODEL #	DESCRIPTION
SDR0135	All 0135 Cabinets
SDR0155	All 0155 Cabinets
SDR0175	All 0175 Cabinets
SDR0200	All 0200 Cabinets
SDR0245	All 0245 Cabinets
SDR0340	All 0340 Cabinets

SINGLE DRAWER RELEASE

- Patented technology prevents opening more than one drawer at a time
- Release mechanism feature ensures that only one drawer will be open at a time—no other drawers can be opened
- Do not use for vehicular or shipboard applications

INDIVIDUAL DRAWER PADLOCK FEATURE

Model # DPF1

- Padlock feature allows a single drawer 30 points or larger, to be locked by a padlock with a latch plate connected to the cabinet and extending through a slot in the face of the drawer
- Available for left, right, or both sides of drawer
- Security panel (SECP1) is recommended for use with this feature to prevent access even when drawer above is removed
- Padlock not included



Individual Drawer Padlock

LOCK-IN/LOCK-OUT LATCHES

- Lock-in/lock-out latches prevent drawers from moving when fully opened or closed
- Raising the latch releases the drawer
- Mandatory for cabinets used in ships, vans, and mobile applications
- Modified drawer fronts require factory installation



Lock-In/Lock-Out Latch



Lock-In/Lock-Out Latches

MODEL #	LOCATION
XXMR	Right-hand side of drawer
XXML	Left-hand side of drawer
XXMRL	Right-hand and left-hand sides of drawer



Technician Toolbox



DRAWER ACCESSORIES

Drawer accessories customize a drawer's interior to your inventory or tools.

- Partitions and dividers can be easily moved and rearranged
- Change interior configurations as inventory or storage requirements change
- Additional accessories not listed are available

DRAWER PARTITIONS

- Partitions span entire width or depth of a drawer
- Slide into slots on drawer walls and fasten to drawer bottom at prepunched locations
- Use with dividers to customize drawer interiors
- Includes hardware for fastening to drawer bottom

DRAWER DIVIDERS

- Use with partitions to subdivide drawer space

NOTE: Dividers that are 9-1/2" (241mm) long and over are supplied with screws for fastening to drawer bottom.

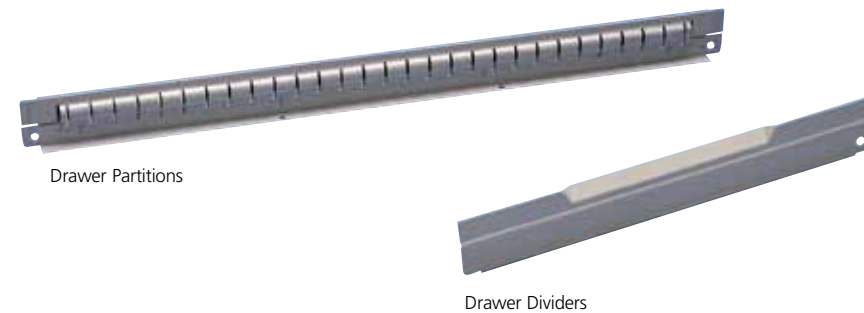

Drawer Partitions

DRAWER TYPE	# OF SPACES	APPROX. LENGTH	FITS DRAWER	FITS DRAWER	FITS DRAWER	FITS DRAWER
			MODELS 20 & 25 1-7/8" (48MM) HT.	MODELS 30 & 35 2-7/8" (73MM) HT.	MODELS 40 & 45 4-1/2" (114MM) HT.	MODELS 50+ 5-1/4" (133MM) HT.
Standard/LW/SV	32	25-1/2" (648mm)	P20*	P30*	P40*	P50*
Extra-Wide	51	40-1/2" (1029mm)	P2051	P3051	P4051	P5051
Double-Wide	70	55-5/8" (1413mm)	P2070	P3070	P4070	P5070
SL, LW XL & DL (front to back)	24	19" (483mm)	P2024	P3024	P4024	P5024

Standard Drawer Dividers

# OF SPACES	APPROX. LENGTH	USABLE COMPARTMENT WIDTH	FITS DRAWER	FITS DRAWER	FITS DRAWER	FITS DRAWER
			MODELS 20 & 25 1-7/8" (48MM) HT.	MODELS 30 & 35 2-7/8" (73MM) HT.	MODELS 40 & 45 4-1/2" (114MM) HT.	MODELS 50+ 5-1/4" (133MM) HT.
2	1-1/2" (38mm)	1-1/8" (29mm)	D2002*	D3002*	—	—
3	2-1/4" (57mm)	1-7/8" (48mm)	D2003*	D3003*	—	—
4	3" (76mm)	2-5/8" (67mm)	D2004*	D3004*	D4004*	D5004*
5	3-7/8" (98mm)	3-1/2" (89mm)	D2005*	D3005*	D4005*	D5005*
6	4-5/8" (117mm)	4-1/4" (108mm)	D2006*	D3006*	D4006*	D5006*
7	5-1/2" (140mm)	5-1/8" (130mm)	D2007*	D3007*	D4007*	D5007*
8	6-1/4" (159mm)	5-7/8" (149mm)	D2008*	D3008*	D4008*	D5008*
9	7" (178mm)	6-5/8" (168mm)	D2009*	D3009*	D4009*	D5009*
10	7-7/8" (200mm)	7-1/2" (190mm)	D2010*	D3010*	D4010*	D5010*
11	8-5/8" (219mm)	8-1/4" (210mm)	D2011*	D3011*	D4011*	D5011*
12	9-1/2" (241mm)	9-1/8" (232mm)	D2012*	D3012*	D4012*	D5012*
13	10-1/4" (260mm)	9-7/8" (251mm)	D2013*	D3013*	D4013*	D5013*
14	11" (279mm)	10-5/8" (270mm)	D2014*	D3014*	D4014*	D5014*
15	11-7/8" (302mm)	11-1/2" (292mm)	D2015*	D3015*	D4015*	D5015*
16**	12-5/8" (321mm)	12-1/4" (311mm)	D2016*	D3016*	D4016*	D5016*
17	13-1/2" (343mm)	13-1/8" (333mm)	D2017*	D3017*	D4017*	D5017*
18	14-1/4" (362mm)	13-7/8" (352mm)	D2018*	D3018*	D4018*	D5018*
19	15" (381mm)	14-5/8" (371mm)	D2019*	D3019*	D4019*	D5019*
20	15-7/8" (403mm)	15-1/2" (394mm)	D2020*	D3020*	D4020*	D5020*
21	16-5/8" (422mm)	16-1/4" (413mm)	D2021*	D3021*	D4021*	D5021*
22	17-1/2" (445mm)	17-1/8" (435mm)	D2022*	D3022*	D4022*	D5022*
23**	18" (457mm)	17-7/8" (454mm)	D2023*	D3023*	D4023*	D5023*
24**	19" (483mm)	18-5/8" (473mm)	D2024*	D3024*	D4024*	D5024*
25	19-7/8" (505mm)	19-1/2" (495mm)	D2025*	D3025*	D4025*	D5025*
26	20-5/8" (524mm)	20-1/4" (514mm)	D2026*	D3026*	D4026*	D5026*
27	21-1/2" (546mm)	21-1/8" (537mm)	D2027*	D3027*	D4027*	D5027*
28	22-1/4" (565mm)	21-7/8" (556mm)	D2028*	D3028*	D4028*	D5028*
29	23" (584mm)	22-5/8" (575mm)	D2029*	D3029*	D4029*	D5029*
32***	25-3/8" (645mm)	25-1/8" (638mm)	DS2032	DS3032	DS4032	DS5032

*Vidmar® Quick Ship products **Also available in straight dividers ***Only available in straight dividers

PLASTIC BINS AND DIVIDERS

- Ideal for storing smaller items
- Bins can quickly be removed for easy handling, issuing, and counting
- Bins can be made smaller with dividers

In any drawer using bins, it is recommended that a single side-to-side partition be installed.

Snap-on plastic label holders and paper labels must be ordered separately.



Plastic Bins

MODEL #	DIMENSIONS (H X W X D)	MAX DIVIDER COUNT	USED WITH DRAWER MODEL #	MAX # OF BINS PER DRAWER
BN2544*	2-1/8" x 3" x 3" (54mm x 76mm x 76mm)	1	20 or 25	64
BN2548*	2-1/8" x 3" x 6-1/8" (54mm x 76mm x 156mm)	1	20 or 25	32
BN2588*	2-1/8" x 6-1/8" x 6-1/8" (54mm x 156mm x 156mm)	1	20 or 25	16
BN25816*	2-1/8" x 6-1/8" x 12-1/4" (54mm x 156mm x 311mm)	3	20 or 25	8
BN3548*	3-3/4" x 3" x 6-1/8" (95mm x 76mm x 156mm)	1	30 or 35	32
BN3588*	3-3/4" x 6-1/8" x 6-1/8" (95mm x 156mm x 156mm)	1	30 or 35	16
BN35816*	3-3/4" x 6-1/8" x 12" (95mm x 156mm x 305mm)	3	30 or 35	8

*Vidmar® Quick Ship

BIN LABEL HOLDERS

Model # BLH02

- Includes paper labels
- Dimensions (H x W) 2-1/8" x 5/8" (54mm x 16mm)

products



Bin Label Holder

Bin Dividers

MODEL #	USED WITH BIN MODEL #
BND254*	BN2544 or BN2548
BND258*	BN2588 or BN25816
BND354*	BN3548
BND358*	BN3588 or BN35816

PLASTIC QUARTER TRAYS

Model # QT20

- Quarter trays take up one-quarter of a standard drawer
- 20 Compartments, 1-1/4 x 2-1/4 x 2-7/8" (32 x 57 x 73mm)
- Both partitions and dividers should be used when using less than a full drawer of quarter trays

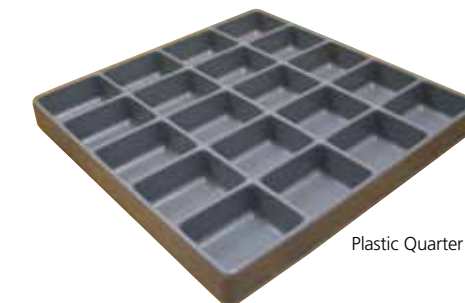

Plastic Quarter Tray

LABEL HOLDERS

- Provides instant identification of drawer compartment contents
- Label holders snap directly onto the divider
- Paper labels and vinyl protective shields included



Label Holders

MODEL #	FITS DIVIDER MODEL # ENDING IN	LENGTH
LH01	Universal	1-3/16" (33mm)
LH04	04 and larger	2-5/8" (67mm)
LH06	06 and larger	4-3/16" (106mm)

Vidmar® Quick Ship products

PLASTIC GROOVE TRAYS AND DIVIDERS

- Available in three sizes
- Store and separate elongated items
- Trays take up one-fifth of a standard drawer
- Can be divided into compartments with groove tray label holders

Plastic Groove Trays and Dividers

MODEL #	DRAWER MODEL	# OF GROOVES	GROOVE OPENING	TRAY WIDTH	QTY. PER DRAWER	LABEL HOLDER*
PGT22	20	5	7/8" (22mm)	5" (127mm)	5	GTL22
PGT37	20	3	1-1/2" (38mm)	5" (127mm)	5	GTL37
PGT58	25	2	2-1/4" (57mm)	5" (127mm)	5	GTL58

*Purchased separately



Plastic Groove Tray



Drill Bit Tray

GROOVE TRAY DIVIDER LABEL HOLDERS

- Supplied with paper labels and vinyl protective shield

Groove Tray Divider Label Holders

MODEL #	USED WITH GROOVE TRAY MODEL
GTL22	PGT22
GTL37	PGT37
GTL58	PGT58



Hanging File Frame

HANGING FILE FRAME

Models PS70, SVPS70, LWPS70, XWPS70

- Designed to be used with model 70 drawer or larger
- One filing kit fills a standard drawer
- Holds two rows of hanging files
- Includes two letter-size steel frames and a file divider

DRAWER LINERS

Use prefix to note drawer size: **Standard (no prefix), Double-Wide (DW), Shallow Depth (LW), Small Version (SV), Extra-Wide (XW), Extra-Wide Shallow Depth (XL), Double-Wide Shallow Depth (DL), Small Version Shallow Depth (SL).** (example: DWML10)

- Helps protect delicate tools and instruments
- Pegboard and fiberboard required for use with drawer bottom posts

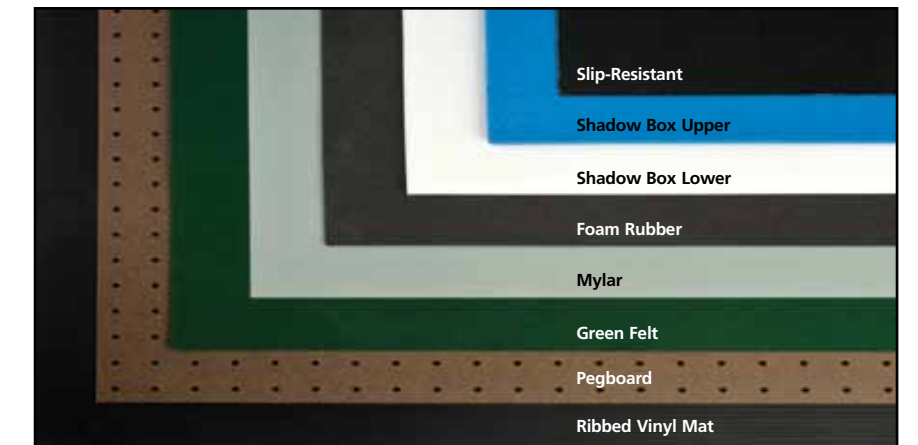

Drawer Bottom Liners

CABINET STYLE	FIBERBOARD (3/8"/10MM)	FOAM RUBBER	GREEN FELT	MYLAR	PEGBOARD	RIBBED VINYL MAT	SHADOW BOX	SLIP-RESISTANT
Standard Cabinets (STD)	FB06	FR01	GF01	ML10	PB02	IA-ST-001-25	SBDIBL/WH	NS01
Shallow Depth Cabinets (LW)	LWFB06	LWFR01	LWGF01	LWML10	LWPB02	IA-LW-001-25	LWSBDIBL/WH	LWNS01
Small Version Cabinets (SV)	SVFB06	SVFR01	SVGF01	SVML10	SVPB02	IA-SV-001-25	SVSBDIBL/WH	SVNS01
Small Version Shallow Depth Cabinets (SL)	SLFB06	SLFR01	SLGF01	SLML10	SLPB02	IA-SL-001-25	SLSBDIBL/WH	SLNS01
Extra-Wide Cabinets (XW)	XWFB06	XWFR01	XWGF01	XWML10	XWPB02	IA-XW-001-25	XWSBDIBL/WH	XWNS01
Extra-Wide Shallow Depth Cabinets (XL)	XLFB06	XLFR01	XLGF01	XLML10	XWPB02	—	XLSBDIBL/WH	XLNS01
Double-Wide Cabinets (DW)	DWFB06	DWFR01	DWGF01	DWML10	DWPB02	IA-DW-001-25	DWSBDIBL/WH	DWNS01
Double-Wide Shallow Depth Cabinets (DL)	DLFB06	DLFR01	DLGF01	DLML10	DLPB02	IA-DL-001-25	DLSBDIBL/WH	DLNS01



Cabinet drawer accessories perfect for all applications

ROLL-OUT SHELVES

Operating on the same carriage system as standard drawers, roll-out shelves are designed to store heavy, bulky, or awkward items, up to 400 lbs. The reinforced shelf allows items to be slid off the side rather than lifted. Roll-out shelves use the same model numbers as cabinet drawers, which range from 20 to 90. Like the drawers, each model number represents a different usable height. Roll-out shelves can be used alone or in combination with drawers.

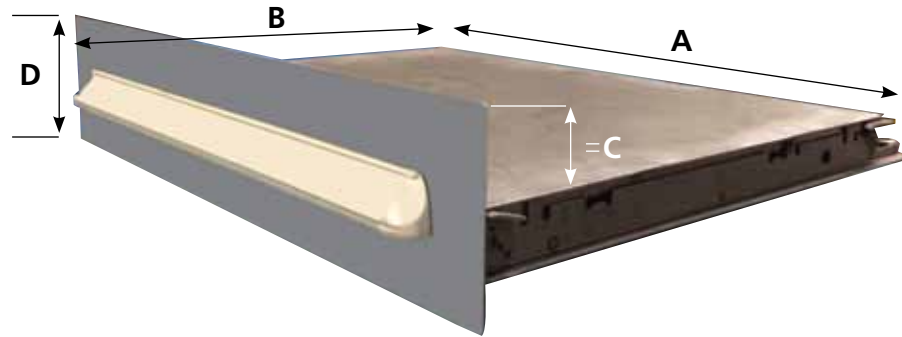

Pictured: STD0340 with RS20 in Bright Blue (S22447)



Pictured: STD0340 with RS20 in Dark Blue (S22578)

Roll-Out Shelf Type

	"A" SIDE TO SIDE	"B" FRONT TO BACK
Standard - STD	26-1/8"	26"
Shallow Depth - LW	26-1/4"	19-9/16"
Small Version - SV	19-1/8"	25-9/16"
Small Version Shallow Depth - SL	19-1/8"	19-9/16"
Extra-Wide - XW	41-1/4"	26"
Extra-Wide Shallow Depth - XL	41-1/4"	19-9/16"
Double-Wide - DW	56-3/8"	26"
Double-Wide Shallow Depth - DL	56-3/8"	19-9/16"

Roll-Out Shelf Model

STANDARD (STD)	SHALLOW DEPTH (LW)	SMALL VERSION (SV)	SMALL VERSION SHALLOW DEPTH (SL)	EXTRA-WIDE (XW)	EXTRA-WIDE SHALLOW DEPTH (XL)	DOUBLE-WIDE (DW)	DOUBLE-WIDE SHALLOW DEPTH (DL)	CLEAR HEIGHT "C"
RS20	LWRS20	SVRS20	SLRS20	XWRS20	XLRS20	DWRS20	DLRS20	1/4"
RS25	LWRS25	SVRS25	SLRS25	XWRS25	XLRS25	DWRS25	DLRS25	1"
RS30	LWRS30	SVRS30	SLRS30	XWRS30	XLRS30	DWRS30	DLRS30	1-3/4"
RS35	LWRS35	SVRS35	SLRS35	XWRS35	XLRS35	DWRS35	DLRS35	2-5/8"
RS40	LWRS40	SVRS40	SLRS40	XWRS40	XLRS40	DWRS40	DLRS40	3-3/8"
RS45	LWRS45	SVRS45	SLRS45	XWRS45	XLRS45	DWRS45	DLRS45	4-1/8"
RS50	LWRS50	SVRS50	SLRS50	XWRS50	XLRS50	DWRS50	DLRS50	4-7/8"
RS55	LWRS55	SVRS55	SLRS55	XWRS55	XLRS55	DWRS55	DLRS55	5-3/4"
RS60	LWRS60	SVRS60	SLRS60	XWRS60	XLRS60	DWRS60	DLRS60	6-1/2"
RS65	LWRS65	SVRS65	SLRS65	XWRS65	XLRS65	DWRS65	DLRS65	7-1/4"
RS70	LWRS70	SVRS70	SLRS70	XWRS70	XLRS70	DWRS70	DLRS70	8-1/8"
RS75	LWRS75	SVRS75	SLRS75	XWRS75	XLRS75	DWRS75	DLRS75	8-7/8"
RS80	LWRS80	SVRS80	SLRS80	XWRS80	XLRS80	DWRS80	DLRS80	9-5/8"
RS85	LWRS85	SVRS85	SLRS85	XWRS85	XLRS85	DWRS85	DLRS85	10-1/2"
RS90	LWRS90	SVRS90	SLRS90	XWRS90	XLRS90	DWRS90	DLRS90	11-1/4"

ROLL-OUT TRAY

Ideal for the storage of heavy, bulky items, the Vidmar® Roll-Out Tray Cabinet provides full access to all stored items at once, plus the ability to fully extend your trays. Experience a new level of convenience combined with everything you expect from Vidmar!



Flanged Door Hinge



Lock-in Latch



Roll-out Tray Cabinet

SHELF CABINETS

Ideal for bulk material storage (gloves, cloths, rags, boxes, etc.), Vidmar® shelf cabinets are available with or without doors and are equipped with a magnetic catch (locks are also available). Shelf cabinets are constructed to the same dimensions and design as Vidmar® standard drawer storage cabinets, allowing the seamless integration of shelf and drawer cabinets. Shelf cabinets can be converted to drawer cabinets at any time.



Preconfigured Shelf Cabinets Model #

STANDARD (STD)	SHALLOW DEPTH (LW)	SMALL VERSION (SV)	SMALL VERSION SHALLOW DEPTH (SL)	EXTRA-WIDE (XW)	EXTRA-WIDE SHALLOW DEPTH (XL)	DOUBLE-WIDE (DW)	DOUBLE-WIDE SHALLOW DEPTH (DL)
SC135X1A	LWS1351A	SVS1351A	SLS1351A	XWS1351A	XLS1351A	DWS1351A	DLS1351A
SC155X1A	LWS1551A	SVS1551A	SLS1551A	XWS1551A	XLS1551A	DWS1551A	DLS1551A
SC175X1A	LWS1751A	SVS1751A	SLS1751A	XWS1751A	XLS1751A	DWS1751A	DLS1751A
SC200X1A	LWS2001A	SVS2001A	SLS2001A	XWS2001A	XLS2001A	DWS2001A	DLS2001A
SC2451XA	LWS2451A	SVS2451A	SLS2451A	XWS2451A	XLS2451A	DWS2451A	DLS2451A
SC340X2A*	LWS3402A*	SVS3402A*	SLS3402A*	XWS3402A*	XLS3402A*	DWS3402A*	DLS3402A*

*All include two 400 lb. capacity shelves

Housing Height

0135	27" (686mm)
0155	30" (762mm)
0175	33" (838mm)
0200	37" (940mm)
0245	44" (1118mm)
0340	59" (1499mm)



Preconfigured Shelf Door Cabinets Model #

STANDARD (STD)***	SHALLOW DEPTH (LW)***	SMALL VERSION (SV)***	SMALL VERSION SHALLOW DEPTH (SL)***	EXTRA-WIDE (XW)**	EXTRA-WIDE SHALLOW DEPTH (XL)**	DOUBLE-WIDE (DW)**	DOUBLE-WIDE SHALLOW DEPTH (DL)**
SD135R/L1AL	LWD13R/L1AL	SVD13R/L1AL	SLD13R/L1AL	XWD1351AL	XLD1351AL	DWD1351AL	DLD1351AL
SD155R/L1AL	LWD15R/L1AL	SVD15R/L1AL	SLD15R/L1AL	XWD1551AL	XLD1551AL	DWD1551AL	DLD1551AL
SD175R/L1AL	LWD17R/L1AL	SVD17R/L1AL	SLD17R/L1AL	XWD1751AL	XLD1751AL	DWD1751AL	DLD1751AL
SD200R/L1AL	LWD20R/L1AL	SVD20R/L1AL	SLD20R/L1AL	XWD2001AL	XLD2001AL	DWD2001AL	DLD2001AL
SD245R/L1AL	LWD24R/L1AL	SVD24R/L1AL	SLD24R/L1AL	XWD2451AL	XLD2451AL	DWD2451AL	DLD2451AL
SD340R/L2AL*	LWD34R/L2AL*	SVD34R/L2AL*	SLD34R/L2AL*	XWD3402AL*	XLD3402AL*	DWD3402AL*	DLD3402AL*

***R/L Please specify right- or left-hand hinge **Double doors *All include two 400 lb. capacity shelves



Shelf/Shelf Door Cabinet Model #

	STANDARD (STD)	SHALLOW DEPTH (LW)	SMALL VERSION (SV)	SMALL VERSION SHALLOW DEPTH (SL)	EXTRA-WIDE (XW)	EXTRA-WIDE SHALLOW DEPTH (XL)	DOUBLE-WIDE (DW)	DOUBLE-WIDE SHALLOW DEPTH (DL)
Housing	xxxx	LWxxxx	SVxxxx	SLxxxx	XWxxxx	XLxxxx	DWxxxx	DLxxxx
400 lb. Shelf	CS40	LWCS40	SVCS40	SLCS40	XWCS40	XLCS40	DWCS40	DLCS40
800 lb. Shelf	CS80	LWCS80	SVCS80	SLCS80	XWCS80	XLCS80	DWCS80	DLCS80
Bottom Pan	BP80	LWBP80	SVBP80	SLBP80	XWBP80	XLBP80	DWBP80	DLBP80
Door	SDDxxx**	SDDxxx**	SVSDDxxx**	SVSDDxxx**	XWSDDxxx	XWSDDxxx	DWSDDxxx	DWSDDxxx
6" Bottom Pan Dividers	SDV06B	-	SDV06B	-	SDV06B	-	SDV06B	-

** Please specify right- or left-hand hinge For xxx substitute with housing Model #

SHELF DOOR LOCKS

- For security, shelf door cabinet locks are available



Doors in Off-White (S22570)

Shelf Door Locks

MODEL #	USED WITH CABINETS
SDL3401	340 Shelf Door Cabinet
SDL2451	245 Shelf Door Cabinet
SDL2001	200 Shelf Door Cabinet
SDL1751	175 Shelf Door Cabinet
SDL1551	155 Shelf Door Cabinet
SDL1351	135 Shelf Door Cabinet

MESH DOORS

- Vidmar® shelf cabinets can also be configured with mesh doors, providing visibility into the cabinet while keeping stored items out of the reach of unauthorized users
- Mesh doors also allow airflow to help evaporate moisture or provide ventilation to heat-generating items



Pictured: STD0155 in Red (S50054) with EMD155RH



Pictured: XW0155 in Hunter Green (S50091) with XWEMD155RH

DOOR OVER DRAWER

- Feature allows a Vidmar drawer or roll-out shelf cabinet to have a door over the drawers
- Is used for added security



SHELF LINERS

- Helps protect delicate tools and instruments
- Pegboard and fiberboard required for use with drawer bottom posts



Shelf Liners

OVERHEAD CABINETS

Ideal for existing cabinet storage systems or new cabinet system installations, Vidmar® overhead storage (OS) cabinets provide additional heavy-duty storage space above cabinets. Overhead cabinets are manufactured to the same dimensions as the rest of Vidmar's cabinets, allowing for seamless modular integration into any Vidmar® cabinet solution.



Housing Height:

- 0110 20.75" (527mm)
- 0135 24.68" (627mm)
- 0155 27.83" (707mm)
- 0175 30.98" (787mm)
- 0200 34.91" (887mm)
- 0245 42.00" (1,067mm)



Preconfigured Overhead Shelf Cabinets Model # (includes 1 - 400lb. shelf)

STANDARD. (STD)	SHALLOW DEPTH (LW)	SMALL VERSION (SV)	EXTRA-WIDE (XW)	EXTRA-WIDE SHALLOW DEPTH (XL)	DOUBLE-WIDE (DW)
OS110X1A	LWO1101A	SVO1101A	XWO1101A	XLO1101A	DWO1101A
OS135X1A	LWO1351A	SVO1351A	XWO1351A	XLO1351A	DWO1351A
OS155X1A	LWO1551A	SVO1551A	XWO1551A	XLO1551A	DWO1551A
OS175X1A	LWO1751A	SVO1751A	XWO1751A	XLO1751A	DWO1751A
OS200X1A	LWO2001A	SVO2001A	XWO2001A	XLO2001A	DWO2001A
OS245X1A	LWO2451A	SVO2451A	XWO2451A	XLO2451A	DWO2451A

Overhead Shelf Cabinets Model

	STANDARD. (STD)	SHALLOW DEPTH (LW)	SMALL VERSION (SV)	EXTRA-WIDE (XW)	EXTRA-WIDE SHALLOW DEPTH (XL)	DOUBLE-WIDE (DW)
OS Cabinet	OSXXXX	LWOSXXXX	SVOSXXXX	XWOSXXXX	XLOSXXXX	DWOSXXXX
400 lb. Shelf	CS40	LWCS40	SVCS40	XWCS40	XLCS40	DWDCS40
Door	SDDXXXX**	LWSDXXXX**	SDDXXXX**	XWSDXXXX	XWSDXXXX	DWSDXXXX
9" Shelf Dividers	SDV09	LWSDV09	SDV09	SDV09	LWSDV09	SDV09
12" Shelf Dividers	SDV12	LWSDV12	SDV12	SDV12	LWSDV12	SDV12
6" Bottom Pan Dividers	SDV06B	-	SDV06B	SDV06B	-	SDV06B

**Please specify right- or left-hand hinge

CABINETS AND DOORS

For cabinets and doors, substitute cabinet height number for "XXX" in model numbers [ex.: OS245 is a 42" (1067mm cabinet)].

SHELVES

For shelves, choose either 400 lb. (181kg) or 800 lb. (362kg) capacity; replace "40" with "80" in shelf model number for 800 lb. capacity shelf.

SHELF DOOR LOCKS

For doors with locks, add "L" to end of Model #.

- Secure shelf door cabinets

SHELF DIVIDERS

For shelf dividers, order either 9" (229mm), Model # SDV09, or 12" (305mm) Model # SDV12. Same size versions are available for shallow depth cabinets: 9", Model # LWSDV09 and 12", Model # LWSDV12.

- Not for use in supporting other stacked cabinets in mezzanine or high-rise applications



Pictured: DWPT0175 with STD0340 Drawer Units in Hunter Green (550091) Housings and Off-White (S22570) Drawers and Shelves



Shelf Door Locks

Doors in Off-White (S22570)

MODEL #	DESCRIPTION
SDL1351	0135 Shelf Door Cabinets
SDL1551	0155 Shelf Door Cabinets
SDL1751	0175 Shelf Door Cabinets
SDL2001	0200 Shelf Door Cabinets
SDL2451	0245 Shelf Door Cabinets
SDL3401	0340 Shelf Door Cabinets



Shelves in Off-White (S22570)



Shelf Dividers in Off-White (S22570)

MOBILE CABINETS

Wherever you need to work, Vidmar® mobile storage cabinets are in on the action. Heavy-duty mobile casters make our mobile cabinets easy to move, allowing you to position them exactly where you need them. Vidmar offers preconfigured mobile storage cabinets, or you can custom-build your mobile cabinet in any size and configuration you choose. All Vidmar® mobile storage cabinets require lock-in/lock-out latches or single-drawer release.



RP1441AL - Four Drawers
 Table Height - 35"
 30" (762mm) Standard Width
 27-3/4" (705mm) Standard Depth
 Shipping Weight: 250 lbs. (1136kg)

DRAWERS	DRAWER MODEL #	USABLE HEIGHT
1	20	2-1/4" (57mm)
1	30	3-7/8" (98mm)
1	35	4-5/8" (117mm)
1	70	10-1/8" (257mm)



RP1200AL - Five Drawers
 Bench Height - 38"
 30" (762mm) Standard Width
 21-3/8" (543mm) Shallow Depth
 Shipping Weight: 208 lbs. (135kg)

DRAWERS	DRAWER MODEL #	USABLE HEIGHT
1	20	2-1/4" (57mm)
1	25	3" (76mm)
1	30	3-7/8" (98mm)
1	40	5-3/8" (137mm)
1	60	8-1/2" (216mm)



RP1978AL - Eight Drawers
 Stand-Up Height - 42"
 45" (1143mm) Extra-Wide Width
 21-3/8" (543mm) Shallow Depth
 Shipping Weight: 401 lbs. (226kg)

DRAWERS	DRAWER MODEL #	USABLE HEIGHT
1	XL20	2-1/4" (57mm)
4	XL20	2-1/4" (57mm)
2	XL30	3-7/8" (98mm)
1	XL40	5-3/8" (137mm)



RP1979AL - Eight Drawers
 Stand-Up Height - 42"
 30" (762mm) Standard Width
 21-3/8" (543mm) Shallow Depth
 Shipping Weight: 345 lbs. (215kg)

DRAWERS	DRAWER MODEL #	USABLE HEIGHT
1	LW20	2-1/4" (57mm)
4	LW20	2-1/4" (57mm)
2	LW30	3-7/8" (98mm)
1	LW40	5-3/8" (137mm)

MOBILE CABINET ACCESSORIES

Mobile caster kit should be specified when ordering mobile cabinets. Options include 2" hard rubber wheels, 5" hard rubber wheels, and 6" polyurethane read locked to polyolefin core. For a full caster kit option chart, visit our Interactive Product Catalog at StanleyVidmar.com.

Additional mobile cabinet accessories include MR latches, cabinet top trays (ideal for keeping small or rolling parts safe and close at hand), tow bars, and battens (used to keep items securely on shelves while being transported or stored shipboard).

CABINET TOP TRAY

- Cabinet top trays attach through knockouts, available on all cabinets
- 1" (25mm) height
- Ideal for keeping small or rolling parts and tools safe and close at hand

CABINET TOP TRAY HANDLE

- Cabinet top tray handle is an integrated top tray and handle

TOW BAR

Model # *UTB-22* (Also order appropriate adapter kit)

Adapter kits:
 Model # *UTBAK-22*, for all housings except shallow depth

Model # *UTBAK-22-LW* for shallow depth housings

- Tow bars are used to tow cabinets in mobile applications
- Attached to base of all housing styles with adapter kit
- Use tow bars only on cabinets with lock-in/lock-out latches
- Use only on cabinet heights of 175 or smaller

Additional Weld Feature

See chart for model numbers

Additional welds are added for towing applications to maintain cabinet strength and performance

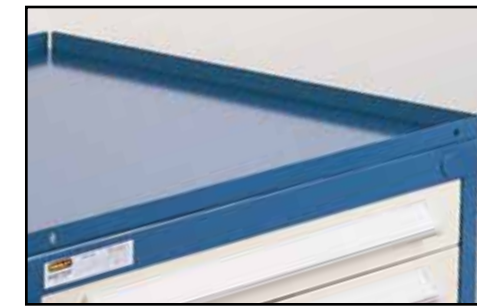

Cabinet Top Tray

Cabinet Top Trays

MODEL #	USED WITH CABINETS
CTTST	Standard Cabinets
CTTSV	Small Version Cabinets
CTTLW	Shallow Depth Cabinets
CTTXW	Extra-Wide Cabinets
CTTDW	Double-Wide Cabinets
CTTXL	Extra-Wide Shallow Depth
CTTDL	Double-Wide Shallow Depth
CTTSL	Small Version Shallow Depth



Cabinet Top Tray Handle

Cabinet Top Tray Handle

MODEL #	USED WITH CABINETS
CTTST Handle	Standard Cabinets
CTTSV Handle	Small Version Cabinets
CTTLW Handle	Shallow Depth Cabinets
CTTXW Handle	Extra-Wide Cabinets
CTTDW Handle	Double-Wide Cabinets
CTTXL Handle	Extra-Wide Shallow Depth
CTTDL Handle	Double-Wide Shallow Depth
CTTSL Handle	Small Version Shallow Depth



Tow Bar

Tow Bars - Additional Weld Feature

MODEL #	USED WITH CABINETS
AWFST	Standard Cabinets, XW, and DW
AWFLW	Shallow Depth Cabinets
AWFSL	Extra-Wide Cabinets
AWFVL	Shallow Depth, Extra-Wide
AWFDW	Double-Wide

CASTERS WITH CHANNEL OPTIONS

- Subject to change visit STANLEYVidmar.com for current images



USED WITH HOUSING NO FEET FEATURE	2" HARD RUBBER WHEEL (ADDS 3" TO CABINET)		5" HARD RUBBER WHEEL (ADDS 7-1/4" TO CABINET W/O FEET)		6" POLYURETHANE TREAD LOCKED TO POLYOLEFIN CORE (ADDS 8-1/4" TO CABINET)		WITHOUT FEET HANDLES (ORDERED SEPARATELY)
	WT. CAP. 200 LB./WHL (90KG)	WHEEL DIA. 2" (50MM)	WT. CAP. 350 LB./WHL (158KG)	WHEEL DIA. 5" (127MM)	WT. CAP. 900 LB./WHL (408KG)	WHEEL DIA. 6" (152MM)	
One Cabinet Mobile Base	4 Swivel Casters With Channel		2 Rigid 2 Swivel Casters With Channel		2 Rigid 2 Swivel Casters With Channel		
Standard	1MB2HRSTS		1MB5HRST		1MB6PPST		MHST
Shallow Depth	1MB2HRLWS		1MB5HRLW		1MB6PPLW		MHLW
Small Version	1MB2HRSVS		1MB5HRSV		1MB6PPSV		MHSV
Extra-Wide	1MB2HRXWS		1MB5HRXW		1MB6PPXW		MHST
Extra-Wide Shallow Depth	1MB2HRXLS		1MB5HRXL		1MB6PPXL		MHLW
Double-Wide	1MB2HRDWS		1MB5HRDW		1MB6PPDW		MHST
Double-Wide Shallow Depth	N/A		1MB5HRDL		1MB6PPDL		MHLW
Small Version Shallow Depth	1MB2HRSL		1MB5HRSL		1MB6PPSL		MHLW
Two Cabinet Mobile Base	6 Swivel Casters With Channel		2 Rigid 2 Swivel Casters With Channel		2 Rigid 2 Swivel Casters With Channel		
Standard	N/A		2MB5HRST		2MB6PPST		MHST
Shallow Depth	N/A		N/A		2MB6PPLW		MHLW
Small Version	N/A		2MB5HRSV		2MB6PPSV		MHSV
Two Cabinet Mobile Base	4 Swivel Casters With Channel						
Standard	2MB2HRSTS		2MB5HRSTS		2MB6PPSTS		MHST
Shallow Depth	2MB2HRLWS		N/A		2MB6PPLWS		MHLW
Extra-Wide	N/A		2MB2HRSVS		2MB6PPXWS		MHST
Three Cabinet Mobile Base			2 Rigid 4 Swivel Casters With Channel		2 Rigid 4 Swivel Casters With Channel		
Standard	N/A		3MB5HRST		3MB6PPST		MHST
Small Version	N/A		N/A		3MB6PPSV		MHSV

UTILITY CARTS

A lightweight, highly mobile storage option, Vidmar® utility carts are a great way to keep tools at hand as you move from task to task. Built with the same Vidmar toughness as the rest of our storage cabinet systems, Vidmar® utility carts are available with your choice of one or two drawers.

- Lightweight, heavy-duty, easy-to-move utility work cart
- 16,910 total cubic inches of storage space. Overall storage capacity 600 lbs.
- Holds up to 150 lbs. per drawer
- Dimensions:
Width (top and bottom) 30"
Depth (top) 21.38", (bottom) 30"

Overall height (with casters) 37"
Weight (empty) 163 lbs.



Utility Carts

MODEL #	DRAWER MODEL#	SHIPPING WEIGHT
RP5000A	LW40	215 lbs.
RP5001A	2-LW20	240 lbs.

VERTICAL DISPLAY CABINETS

Designed to keep tools visible and identifiable from a distance, Vidmar® vertical display cabinets store tools on a pegboard behind locking Plexiglas® bypass doors. Vertical display cabinets can be installed on top of most Vidmar® drawer storage cabinets.

Vertical Display

MODEL #	HEIGHT	LENGTH	WIDTH
VDC30	30" (762mm)	21" (543.05mm)	30" (762mm)
VDC60	30" (762mm)	21" (543.05mm)	60" (1524mm)



INDUSTRIAL WORKCENTERS

The new Vidmar® industrial workcenter product line offers the quality and versatility of modular drawer storage. With the redesigned workcenter units, the same organization and storage efficiencies have arrived at the technician's workspace.

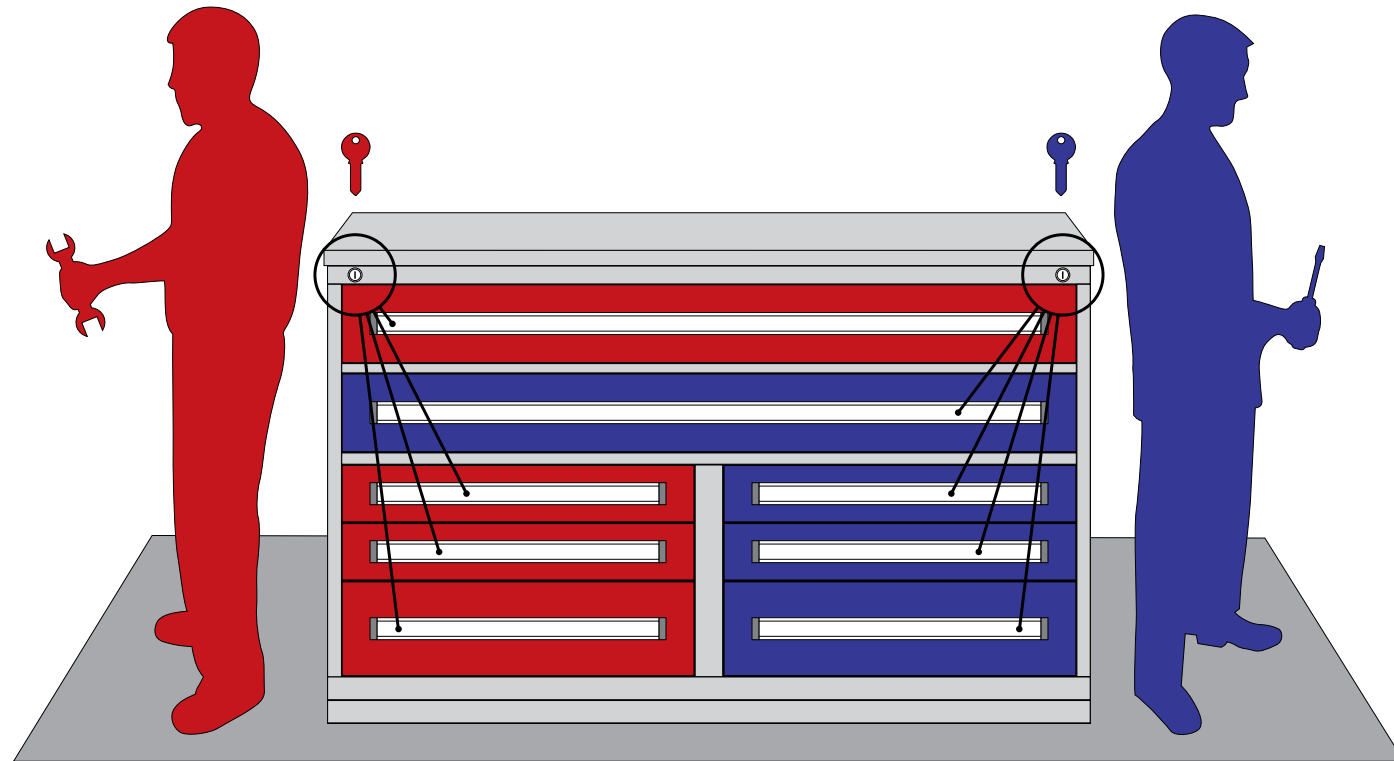

The new Vidmar® industrial workcenter enables two workers to share the same cabinet yet maintain separate lockable drawers.



WELD CELL SUPPORT



TOOL & DIE MANAGEMENT



METAL FABRICATION



CNC PROTOTYPING & MACHINING



HEAVY TRUCK/AUTOMOTIVE REPAIR



ROBOTIC TESTING CELLS



GENERAL MANUFACTURING



INDUSTRIAL ELECTRICIAN

PRECONFIGURED INDUSTRIAL WORKCENTERS

- Drawer capacity and drawer carriage system capacity 400 lbs.
- Heavy-duty casters, spring-loaded casters available, 900 lbs. per caster
- Mobile handles match cabinet color
- Doors and drawers keyed alike
- Black end caps standard



RP1954AL - Five Drawers

Workcenter Height - 42" (includes work surface)
45" Extra-Wide Width
27-3/4" Standard Depth

DRAWERS	DRAWER MODEL #	USABLE HEIGHT	COMPARTMENTS	LOADING DIAGRAM #
1	XW30BKFW	3-7/8" (98mm)	1	-
1	SV25BK	3" (76mm)	1	-
2	SV40BK	5-3/8" (173mm)	1	-
1	SV60BK	8-1/2" (216mm)	1	-
1	SVCS40	Shelf	0	-

RP1952AL - Five Drawers

Workcenter Height - 42" (includes work surface)
60" Double-Wide Width
27-3/4" Standard Depth

DRAWERS	DRAWER MODEL #	USABLE HEIGHT	COMPARTMENTS	LOADING DIAGRAM #
1	DW30BKFW	3-7/8" (98mm)	1	-
1	25BK	3" (76mm)	1	-
2	40BK	5-3/8" (173mm)	1	-
1	60BK	8-1/2" (216mm)	1	-
1	CS40	Shelf 0	-	-



PRECONFIGURED INDUSTRIAL WORKCENTERS

Dimensions:

- Cabinet widths: 45" and 60" wide
- Single drawer usable space;
45" Model: 40-1/4" x 25-1/8"
- 60" model: 55-3/8" x 25-1/8"
- Drawer bank usable space;
45" Model: 17-7/8" x 25-1/8"
- 60" Model: 25-1/8" x 25-1/8"
- Cabinet heights: 31" (0175) and 35" (0200)
- Drawer heights: standard Vidmar sizes 020 – 090
- Door heights: Standard Vidmar sizes 140 – 165 Series
- Black end caps standard

Options:

- Adjustable shelves available in 400 lbs. and 800 lbs. capacities
- Drawer partitions and dividers available
- Ribbed rubber mat or 1-3/4" thick hardwood tops
- Special configurations available upon request



RP1955AL - Ten Drawers

Workcenter Height - 42" (includes work surface)
45" (1143mm) Extra-Wide Width
27-3/4" (705mm) Standard Depth

DRAWERS	DRAWER MODEL #	USABLE HEIGHT	COMPARTMENTS	LOADING DIAGRAM #
1	XW30BKFW	3-7/8" (98mm)	1	-
3	SV25BK	3" (76mm)	1	-
1	SV40BK	5-3/8" (137mm)	1	-
1	SV50BK	7" (178mm)	1	-
2	SV30BK	3-7/8" (98mm)	1	-
1	SV35BK	4-5/8" (117mm)	1	-
1	SV70BK	10-1/8" (257mm)	1	-

RP1953AL - Ten Drawers

Workcenter Height - 42" (includes work surface)
60" (1524mm) Double-Wide Width
27-3/4" (705mm) Standard Depth

DRAWERS	DRAWER MODEL #	USABLE HEIGHT	COMPARTMENTS	LOADING DIAGRAM #
1	DW30BKFW	3-7/8" (98mm)	1	-
3	25BK	3" (76mm)	1	-
1	40BK	5-3/8" (137mm)	1	-
1	50BK	7" (178mm)	1	-
2	30BK	3-7/8" (98mm)	1	-
1	35BK	4-5/8" (117mm)	1	-
1	70BK	10-1/8" (257mm)	1	-

PASS-THROUGH CABINETS

- Ideal for storage of long bulky items
- Available with or without doors and shelves
- Stand alone or back-to-back to best meet your storage needs
- Available with or without doors and shelves



Pass-Through Cabinet Model #

	PT (STD)	XWPT	XLPT	DWPT	DLPT
Pass-Through Housing	PTXXXX	XWPTXXXX	XLPTXXXX	DWPTXXXX	DLPTXXXX
Door	SDDXXXR/LH*	XWSDDXXXX	XWSDDXXXX	DWSDDXXXX	DWSDDXXXX
Shelf	PTCS40	XWPTCS40	XLPTCS80	DWPTCS40	DLPTCS80
Bottom Pan	PTBP80	XWPTBP80	XLPTBP80	DWPTBP80	DLPTBP80

** Please specify right- or left-hand hinge

COMPUTER CABINETS

- Ultimate platform for high-impact computer storage and performance
- Designed to accommodate an array of computer housing situations, from shop floors to warehouses to military shipboards
- Available in other sizes



PCC0340A
30" W x 27-3/4" D x 65" H
(762mm W x 711mm D x 1651mm H)



PCM0340A
30" W x 27-3/4" D x 65" H
(762mm W x 711mm D x 1651mm H)

SAFETY CABINETS

- Constructed from 180-gauge steel with double walls on tops, sides, bottoms, and doors (double walls integrate a 1-1/2" airspace for added safety)
- Two side vents, both with 2" threaded fittings
- Fire baffle end cap
- High-gloss epoxy powder coatings inside and out



Acid/Corrosive Safety Cabinet

- Designed for the storage of up to 5 gallon containers of flammable and nonflammable acids and corrosive liquids
- Coated with blue epoxy powder coating for superior protection against chemical spills and splashes

Acid/Corrosive Safety Cabinet Models

MODEL #*	DOOR SPECS	CAPACITY	APPROVAL	WIDTH	DEPTH	HEIGHT	SHELF DEPTH	SHELVES	SHELF TRAYS	BTM TRAYS	WEIGHT
CAC30M	2 Doors	30 gal. (114L)	FM	43" (1092mm)	18" (457mm)	44" (1118mm)	14-3/4" (375mm)	1	1	1	253 lbs. (115kg)
CAC45M	2 Doors	45 gal. (170L)	FM	43" (1092mm)	18" (457mm)	65" (1651mm)	14-3/4" (375mm)	2	2	1	351 lbs. (159kg)
CAC60M	2 Doors	60 gal. (227L)	FM	31-1/4" (794mm)	31-1/4" (794mm)	65" (1651mm)	28" (711mm)	2	2	1	363 lbs. (165kg)

*M — Manual doors

Weight includes packaging

Paint/Ink Safety Cabinet

- Safely store printing inks and other paint products
- Cabinets finished with a high-gloss yellow epoxy

Paint/Ink Safety Cabinet Models

MODEL #	DOOR SPECS	CAPACITY	APPROVAL	WIDTH	DEPTH	HEIGHT	SHELF DEPTH	SHELVES	WEIGHT
PIC40M	2 Doors	40 gal. (151L)	FM	43" (1092mm)	18" (457mm)	44" (1118mm)	14-3/4" (375mm)	3	272 lbs. (123kg)
PIC60M	2 Doors	60 gal. (227L)	FM	43" (1092mm)	18" (457mm)	65" (1651mm)	14-3/4" (375mm)	5	380 lbs. (172kg)

Weight includes packaging

Flammable Safety Cabinet

- Keep required flammable liquids safely near work areas
- Coated with high-gloss yellow HazMat finish
- Meets OSHA requirements, NFPA Code 30 requirements, and FM approval

Flammables Safety Cabinet Models

MODEL #*	DOOR SPECS	CAPACITY	APPROVAL	WIDTH	DEPTH	HEIGHT	SHELF DEPTH	SHELVES	WEIGHT
FLC30M	2 Doors	30 gal. (114L)	FM	43" (1092mm)	18" (457mm)	44" (1118mm)	14-3/4" (375mm)	1	247 lbs. (112kg)
FLC30SC	2 Doors	30 gal. (114L)	FM	43" (1092mm)	18" (457mm)	44" (1118mm)	14-3/4" (375mm)	1	257 lbs. (117kg)
FLC45M	2 Doors	45 gal. (170L)	FM	43" (1092mm)	18" (457mm)	65" (1651mm)	14-3/4" (375mm)	2	342 lbs. (155kg)
FLC45SC	2 Doors	45 gal. (170L)	FM	43" (1092mm)	18" (457mm)	65" (1651mm)	14-3/4" (375mm)	2	353 lbs. (160kg)
FLC60M	2 Doors	60 gal. (227L)	FM	31-1/4" (794mm)	31-1/4" (794mm)	65" (1651mm)	28" (711mm)	2	354 lbs. (161kg)
FLC60SC	2 Doors	60 gal. (227L)	FM	31-1/4" (794mm)	31-1/4" (794mm)	65" (1651mm)	28" (711mm)	2	364 lbs. (165kg)

*M — Manual doors

Weight includes packaging

Safety Cabinet Accessories

MODEL #	TYPE	DESCRIPTION
CAS-XX	Epoxy-Coated Metal Shelf	Specify Capacity of 30, 45, or 60 gal. (114, 170, or 227L)*
FLS-XX	Metal Shelf	Specify Capacity of 30, 45, or 60 gal. (114, 170, or 227L)*
PIS-XX	Metal Shelf	Specify Capacity of 40 or 60 gal. (151 or 227L)*
CAPBT-XX	Poly. Bottom Tray	Specify Capacity of 30, 45, or 60 gal. (114, 170, or 227L)*
CAPST-XX	Poly. Shelf Tray	Specify Capacity of 30, 45, or 60 gal. (114, 170, or 227L)*
FLAK	Adapter Kits	All Flammable
CAAK	Adapter Kits	All Acid/Corrosive
PIAK	Adapter Kits	All Paint/Ink

Safety Cabinet Accessories

- Accessories include metal shelves, epoxy-coated metal shelves, polyethylene bottom trays, polyethylene shelf trays, and self-closing adapter kits

FULLY LOADED MODULARITY

Completely modular, Vidmar® mezzanine systems can be reconfigured as often as necessary—even when fully loaded. Constructed to the same super-tough standards as the rest of Vidmar’s storage components, mezzanines are available in a variety of convenient systems.

MiniMezz™ System

- Consists of two rows of stacked storage cabinets plus stairs, railings, and a walking mat placed over the lower row
- Configure with any Vidmar cabinet (recommend standard 340’s for bottom row)



Mezzanine expansion modules allow your system to grow as you grow. Aisle and pass-through modules enable you to build your system around your unique space requirements and traffic patterns.



MaxiMezz™ System

- Cabinets stacked two-high into rows, with an intermediate shelf cabinet between the top and bottom cabinets
- Includes walkway support system, grating, stairs, and railings
- Multiple configurations available

All mezzanine systems are backed by Vidmar’s lifetime warranty.



MaxiMezz™ includes walkway support system, grating and railings



WEAPONS STORAGE AND CRADLE

The security of your weapons is of the highest priority. So is knowing they're exactly where you need them when you need them most. Settle for nothing less than Vidmar heavy-duty weapons storage:

- Highest level of security for contents with integrated locking mechanism
- Additional layer of safety and security with shock bar
- Verified as meeting the requirements of paragraph 4 (a-d) of the Small Arms Storage Rack Certification Document, part of **AR 190-11** for the physical security of arms, ammunition, and explosives
- Weapons cradles configured to your unique requirements
- Easily integrated into a variety of Vidmar storage systems
- Extreme space savings over racking-style weapon storage—approximately **40-45 weapons vs. 10**



Pictured: STD0175 with 2-35, 1-40, 1-65 with STPD165 HLB1751, HLBL1751 and Hardwood Top in Dark Blue (S22578)



Pictured: DW70 Drawer with WCP-UNIV-ST in Dark Blue (S22578)



Whether you need to store a roomful of rifles or a warehouse full of large field weapons, Vidmar weapons cradles can be configured to accommodate your precise needs.



Available for an array of standard-issue weaponry, Vidmar weapons cradles ensure that none of your weaponry ends up in the wrong hands.



Pictured: DW0340 with 2-DW65, 3-DW70, HLB3401, and HLB3401 in Dark Blue (S22578)

SECURE, CUSTOMIZABLE, AND BUILT TO LAST

- Designed to meet the unique needs of military and law enforcement, Vidmar® Vertical Weapon Storage System is our most versatile weapons storage solution yet
- Strong and secure, it keeps up to 18 M4s, M16s, or M870 shotguns protected and can be custom-configured to store various combinations of weaponry, ammunition, and equipment



Weapons able to be stored

- | | |
|------------------|-----------------------------|
| M9 (9MM) | GAU19 |
| M16 | GAU21 |
| M4 with scopes | SNIPER RIFLES |
| M240 with scopes | FOREIGN WEAPONS |
| M249 | SCOPES |
| M2 | TRIPODS |
| M203 | Satellite Navigation System |
| M320 | NVG |
| MK19 | Bayonet |
| M1200 | Laser Marker |
| M134 | NSN AVAILABLE |
| M870 | (on selected cabinets) |
| M3P | |

High-Density Configurations



- 4 M2s or M19s
- 6 M240s or M249s
- 12 or 18 M4s
- 12 or 18 M16s
- 12 or 18 M870s

Ultimate customization



Shelves & Dividers



Ammo Storage & Boxes



Horizontal Rifle Mount



Pistol Cradles (and clips)



Pistol Post



Rifle Base



Stationary Barrel Cradle



Mobile Barrel Cradle

Safety



Fully secure with two hasp locks secure points plus the ability to bolt or daisy-chain with other cabinets

Mobility

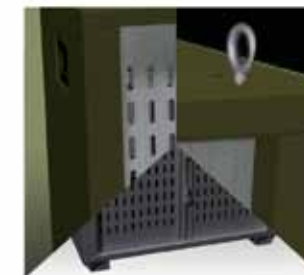

Easy deployment with mobile pallet base, handle, or optional lifting eye

Accessibility



See what's inside with robust, perforated, horizontal tambour doors

Modularity



Conveniently stacks and integrates with other Vidmar systems to save space

RAPID DEPLOYMENT CONTAINER INSERT

Flexible. Expandable. Dependable.

- Designed for high density storage of tools, parts, and weapons
- Custom-configured for new or existing quad-cons, tri-cons, and 20-foot containers
- Customizable drawer options as well as a four-way forkliftable base for quick and easy deployment
- Handles loads up to 4,000 lbs. per individual unit or 8,000 lbs. per stacked unit



Deployment base accepts pallet jacks for transporting around the facility without a fork truck



Units available with cross bracing or panels depending on storage and security needs



Built to last with Vidmar's lifetime warranty

SAFELY STORE YOUR PERSONAL PROTECTION EQUIPMENT (PPE) AND OTHER GEAR.

Vidmar makes the protection and organization of PPE effortless.

- Dedicated drawer storage that prevents the unnecessary handling of items, thereby increasing the shelf life of expensive PPE
- Identical drawer loading diagrams that help expedite frequent PPE inspections
- Expanded storage space to store outerwear, boots, and other personal items
- Space-saving personal protection solutions that can reduce your overall footprint
- Flexible modular storage solutions that can be infinitely expanded



Lockable upper storage compartment protects your belongings



Store everything from breathing apparatuses and ear/eye protection to gloves and clothing



Locker hooks

ESD CABINETS

- Full line of Electro-Static Dissipative (ESD)-protective storage equipment designed to help create a static-safe work environment
- All StaticGard™ storage components adhere to ESD Association Standards, protecting against static damage both on and below your work surfaces



ESD Cabinets

STATICGARD™ WORKSTATIONS

- All StaticGard™ workstations feature a static-dissipative top with a common grounding point for equipment and personnel, plus wrist strap.
- Preconfigured StaticGard™ workstations include StaticGard™ Maintenance Workstation, StaticGard™ Technician's Workstation, StaticGard™ Inspector's Workstation, and StaticGard™ Packer's Workstation
- StaticGard™ Sentry 100 Workstation, tested and certified to 100 volts using ESD Association criteria
- StaticGard™ workstations can also be custom-configured to any specifications your workspace requires



StaticGard™ Workstations: EPW-1



StaticGard™ Workstations: EIW-1



StaticGard™ Workstations: EMW-1

STATICGARD™ ACCESSORIES

Vidmar offers a number of accessories designed to make sure your StaticGard™ components meet your every need:

- **Mobile Casters:** Turn your StaticGard™ storage equipment into mobile StaticGard™ storage equipment
- **Partitions & Dividers:** StaticGard™ drawer partitions and dividers are made with a special coating and materials that make them safe for use in static-sensitive areas
- **Quarter Trays:** Quarter trays take up one-quarter of a standard drawer and are divided into 20 equal-sized compartments
- **Bins & Bin Dividers:** Ideal for smaller items, plastic bins and dividers can be easily removed for handling, issuing, and counting. Bins can be divided into smaller compartments with bin dividers; use snap-on label holders and paper labels to organize bin contents
- **Customize your StaticGard™ drawers** into any configuration you need



StaticGard™ Maintenance Workstation: EMW-1

DRAWERS	DRAWER MODEL #	USABLE HEIGHT	COMPARTMENTS	LOADING DIAGRAM #
CAB1				
1	SG20	2-1/4" (57mm)	64	SGLDQT88
1	SG20	2-1/4" (57mm)	24	SGLD86
1	SG20	2-1/4" (57mm)	64	SGLDBN48
1	SG50	7" (178mm)	12	SGLD108
1	SG65	9" (229mm)	8	SGLD168
CAB2				
1	SG20	2-1/4" (57mm)	24	SGLD85
1	SG20	2-1/4" (57mm)	32	SGLD48
1	SG30	3-7/8" (98mm)	24	SGLD85
1	SG30	3-7/8" (98mm)	20	SGLD86
1	SG30	3-7/8" (98mm)	16	SGLD88
1	SG30	3-7/8" (98mm)	12	SGLD108
1	SG40	5-3/8" (137mm)	12	SGLD108
1	SG50	7" (178mm)	8	SGLD168
1	SG90	13-1/4" (337mm)	8	SGLD168

Also includes: SGB1751, SGFRBC042, SGWS72361, SGWSS721820ABA, SGBPWSS7220A, FL04807200

PRECONFIGURED STATICGARD™ WORKSTATIONS

- StaticGard™ workstations are available in many more preconfigured styles, and can also be custom-configured to any specifications you may require

All Vidmar® cabinets and workstations can be converted to StaticGard™ cabinets and workstations.



StaticGard™ Technician's Workstation: ETW-1

DRAWERS	DRAWER MODEL #	USABLE HEIGHT	COMPARTMENTS	LOADING DIAGRAM #
1	SG20	2-1/4" (57mm)	64	SGLDBN64
1	SG25	3" (76mm)	64	SGLDBN64
1	SG25	3" (76mm)	16	SG88
1	SG35	4-5/8" (117mm)	16	SG88
1	SG50	7" (178mm)	9	SGLD1010

Also includes: SGB1551, SGFRBC042, SGWS72361, SGWSS721820ABA, SGBPWSS7220A, FL04807200



StaticGard™ Inspector's Workstation: EIW-1

DRAWERS	DRAWER MODEL #	USABLE HEIGHT	COMPARTMENTS	LOADING DIAGRAM #
2	SG20	2-1/4" (57mm)	64	SGLDBN64
1	SG25	3" (76mm)	16	SGLD88
1	SG40	5-3/8" (137mm)	16	SGLD88
1	SG50	7" (178mm)	9	SGLD1010

Also includes: SGBC1551, SGFRBC042, SGWS72361, SGWS5721820, FL048072W



StaticGard™ Packer's Workstation: EPW-1

DRAWERS	DRAWER MODEL #	USABLE HEIGHT	COMPARTMENTS	LOADING DIAGRAM #
1	SG20	2-1/4" (57mm)	24	SGLD85
1	SG20	2-1/4" (57mm)	20	SGLD86
1	SG45	6-1/4" (159mm)	16	SGLD88
1	SG90	13-1/4" (337mm)	4	SGLD1616

Also includes: SGBC1551, SGFRBC042, SGWS72361

StaticGard™ Preconfigured 0175
SGSEP1023AL - Five Drawers

DRAWERS	DRAWER MODEL #	USABLE HEIGHT	COMPARTMENTS	LOADING DIAGRAM #
1	SG20	2-1/4" (57mm)	24	SGLD58
1	SG25	3" (76mm)	20	SGLD68
1	SG30	3-7/8" (98mm)	20	SGLD68
1	SG40	5-3/8" (137mm)	16	SGLD88
1	SG60	8-1/2" (216mm)	12	SGLD108

StaticGard™ Preconfigured 0175
SGSEP1004AL - Six Drawers

DRAWERS	DRAWER MODEL #	USABLE HEIGHT	COMPARTMENTS	LOADING DIAGRAM #
1	SG20	2-1/4" (57mm)	24	SGLD58
1	SG20	2-1/4" (57mm)	20	SGLD68
1	SG25	3" (76mm)	16	SGLD88
1	SG30	3-7/8" (98mm)	20	SGLD68
1	SG30	3-7/8" (98mm)	16	SGLD88
1	SG50	7" (178mm)	12	SGLD108

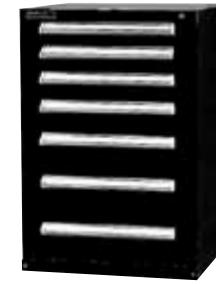

StaticGard™ Preconfigured 0245
SGRP2102AL - Seven Drawers

DRAWERS	DRAWER MODEL #	USABLE HEIGHT	COMPARTMENTS	LOADING DIAGRAM #
1	SG20	2-1/4" (57mm)	32	SGLD84
1	SG25	3" (76mm)	20	SGLD86
1	SG30	3-7/8" (98mm)	20	SGLD86
1	SG30	3-7/8" (98mm)	16	SGLD88
1	SG40	5-3/8" (137mm)	12	SGLD108
1	SG50	7" (178mm)	8	SGLD168
1	SG50	7" (178mm)	6	SGLD1610

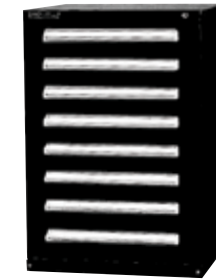

StaticGard™ Preconfigured 0245
SGSEP2029AL - Eight Drawers

DRAWERS	DRAWER MODEL #	USABLE HEIGHT	COMPARTMENTS	LOADING DIAGRAM #
7	SG30	3-7/8" (98mm)	20	SGLD68
1	SG35	4-5/8" (117mm)	20	SGLD68

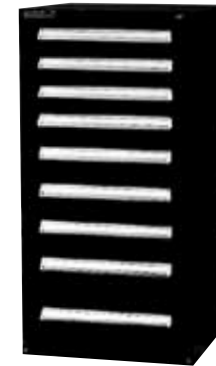

StaticGard™ Preconfigured 0340
SGSEP3144AL - Nine Drawers

DRAWERS	DRAWER MODEL #	USABLE HEIGHT	COMPARTMENTS	LOADING DIAGRAM #
1	SG30	3-7/8" (98mm)	24	SGLD58
1	SG30	3-7/8" (98mm)	20	SGLD68
1	SG30	3-7/8" (98mm)	16	SGLD88
1	SG30	3-7/8" (98mm)	12	SGLD108
1	SG40	5-3/8" (137mm)	20	SGLD68
1	SG40	5-3/8" (137mm)	16	SGLD88
1	SG40	5-3/8" (137mm)	12	SGLD108
1	SG40	5-3/8" (137mm)	8	SGLD168
1	SG60	8-1/2" (216mm)	12	SGLD108



StaticGard™ Preconfigured 0340
SGSEP3140AL - Nine Drawers

DRAWERS	DRAWER MODEL #	USABLE HEIGHT	COMPARTMENTS	LOADING DIAGRAM #
1	SG30	3-7/8" (98mm)	24	SGLD58
1	SG30	3-7/8" (98mm)	20	SGLD68
1	SG35	4-5/8" (117mm)	16	SGLD88
1	SG35	4-5/8" (117mm)	12	SGLD108
1	SG40	5-3/8" (137mm)	20	SGLD68
2	SG40	5-3/8" (137mm)	16	SGLD88
1	SG45	6-1/4" (159mm)	12	SGLD108
1	SG45	6-1/4" (159mm)	8	SGLD168



Built Vidmar-tough for performance that lasts and ergonomically designed to ensure proper body support, Tough Seating is available in an array of styles for specific job tasks. See page 106

**FULFILL LEAN, 6S,
AND KAIZEN STORAGE
REQUIREMENTS**

- Ideal for manufacturing facilities, military, and businesses working on Lean-related initiatives
- Instant Visibility: Clear acrylic doors allow at-a-glance tool and/or parts inventory. Or choose the solid hinged door option with metal pegboard inserts to optimize every inch of the cabinet
- Point-of-Use Storage: Store frequently used items where you need them. Choose from various widths and heights
- Secure Storage: Heavy-duty lock and key system that is virtually impossible to duplicate enables the safe storage of valuable items in a visible location
- Lifetime Guarantee: We protect your investment. All Vidmar® cabinets are backed by this unparalleled industry promise



Side and rear panel pegboard for organized tool storage

Available in 30, 45, 60" wide and 17, 27, 30, 33, and 44" tall



Metal pegboard inserts

Solid hinged doors



6S cabinets optimize workflow and improve efficiency



Ideal for point-of-use storage



NC TOOL STORAGE

- Start working more efficiently by organizing your NC tools as well as your inventory
- Constructed from extruded aluminum, Vidmar® NC tool storage components are designed to carry all of your tools in a safe, well-organized fashion
- Choose your Vidmar® tool holders based on the size and style of the tool assemblies to be handled: V-flange tooling, straight shank tooling, or modular tooling

23" TOOLHOLDER INSERTS

- Toolholder inserts 23" (584mm) are used with lift-out trays and accomplish the same purpose as single toolholder inserts but when side-to-side spacing of tool assemblies is constant

25" FIXED TOOLHOLDERS

- Fixed toolholders 25" long (635mm) are used when side-to-side spacing of tool assemblies is constant and removable toolholders are not required
- Lift-out tool trays are used to move multiple tool assemblies by hand from tool taxis to tool storage devices or workbenches.

Note: Lift-out trays are not recommended with tools larger than 40 V-flange due to ergonomic considerations.



Pictured: VTT200 with 8-TH2532M5 in Bright Blue (S22447)



Pictured: STD02W with 1-20, 3-30, 1-90, 1-DRPs02 with 5-TH2532M5 in Bright Blue (S22447) Housing and Off-White (S22570) Drawers



23" (584mm) Toolholder Inserts



25" (635mm) Fixed Toolholders

Threestepstodeterminewhich toolholderarrangementisbest for you.

1. Decide whether fixed toolholders or lift-out trays will work best
2. If lift-out tool trays are used 23" (584mm) long toolholder inserts will work best for you
3. Choose the specific model number based on the size and style of tool assemblies to be handled

CNC TOOL STORAGE CABINET

- Available in two heights and 12 drawer configurations
- Includes patented Single Drawer Release feature to prevent opening more than one drawer at a time
- Models listed include five 25" (635mm) fixed toolholders in each drawer
- All CNC cabinets must be securely anchored to the floor or bolted back to back
- Drawers may also have a full front

TOOL TAXI

- Designed to meet your tool storage and delivery requirements
- Available with a range of accessories including: rear tray, storage cabinet with lockable door, adjustable shelf, card holder for paperwork, etc.
- For increased capacity, fixed 22" (559mm) toolholders can be provided for attachment to the front or rear of the tool taxi



NC Tool Storage



Model # VTT200xx/N



Model # VTT222xx/N



Model # VTT211xx/N

FLOOR STAND TOOL RACK

Model # FLTHR

- A simple inexpensive means of storing tooling at machining centers or work areas
- Either single or 23" (584mm) toolholder inserts (both shown) attach to extruded aluminum toolholder rails without screws or hand tools
- Three model THR-23 toolholder rails are included
- Up to 10 positions are available for toolholder rails on each side
- Toolholders and trays are ordered separately
- 27-1/4" (705mm) x 26-3/4" (679mm) x 59" (1499mm)

Note: Shipped knocked down. All floor stands should be securely anchored.



Floor Stand Tool Rack

UNIVERSAL FLOOR STAND

Model # FLTS

- Designed to work with tool taxis or CNC storage cabinets
- Provide ready access to preset tooling adjacent to machining areas
- The tool stand will accept either 10 fixed toolholders (as shown), six lift-out trays, or a combination of each
- Toolholders and trays are ordered separately
- 24-3/16" (614mm) x 28" (711mm) x 59-3/16" (1503mm)

Note: Shipped knocked down. All floor stands should be securely anchored.



Universal Floor Stand

BENCHTOP TOOL STAND

Model # BTTS

- Stores three rows of toolholders or lift-out trays
- Accepts either lift-out trays or fixed toolholders
- 18-7/16" (468mm) x 27" (686mm) x 12-3/16" (310mm)
- Shipped knocked down



Benchtop Tool Stand

BENCHTOP TOOL RACK

Model # BTTHR

- Holds tooling on a bench or other work surface
- 8" (203mm) x 24" (610mm) x 8" (203mm)
- Includes one THR-23 toolholder rail
- Toolholders not included
- Shipped knocked down



Benchtop Tool Rack

TOOLHOLDERS AND ACCESSORIES



V-Flange



Straight Shank



Modular-KM

	TOOL SIZE	23" (584MM) TOOLHOLDER INSERT		25" (635MM) TOOLHOLDER	
		MODEL #	TOOL CAP.	MODEL #	TOOL CAP.
V-Flange	050 V-Flange	TH2350V5	5	TH2550V5	5
	45 V-Flange	TH2345V5	5	TH2545V5	5
	40 V-Flange	TH2340V8	8	TH2540V8	8
	30 V-Flange	TH2330V8	8	TH2530V8	8
Straight Shank	2-1/2" (64mm) St. Shank	TH23250ST5	5	TH25250ST5	5
	2-1/4" (57mm) St. Shank	TH23225ST5	5	TH25225ST5	5
	2" (51mm) St. Shank	TH23200ST8	8	TH25200ST8	8
	1-3/4" (44mm) St. Shank	TH23175ST8	8	TH25175ST8	8
	1-1/2" (38mm) St. Shank	TH23150ST8	8	TH25150ST8	8
	1-1/4" (32mm) St. Shank	TH23125ST8	8	TH25125ST8	8
	1" (25mm) St. Shank	TH23100ST8	8	TH25100ST8	8
Modular-CAPTO		TH23C38	8	TH25C38	8
		TH23C48	8	TH25C48	8
		TH23C58	8	TH25C58	8
		TH23C68	8	TH25C68	8
		TH23C85	5	TH25C85	5
Modular-HSK		TH23HSK328	8	TH25HSK328	8
		TH23HSK408	8	TH25HSK408	8
		TH23HSK508	8	TH25HSK508	8
		TH23HSK638	8	TH25HSK638	8
		TH23HSK805	5	TH25HSK805	5
Modular-KM <small>(special adapters also available for TM Smith tooling)</small>	32KM Modular	TH2332M8	8	TH2532M8	8
	40KM Modular	TH2340M8	8	TH2540M8	8
	50KM Modular	TH2350M5	5	TH2550M8	8
	63KM Modular	TH2363M5	5	TH2563M5	5
Miscellaneous	Blank Aluminum	TH23000	Variable	TH25000	Variable
	Blank Alum (Short)	TH2300S0	Variable	TH2500S0	Variable
	#200 Kwik Switch	TH23200Q10	10	TH25200Q10	10
	#300 Kwik Switch	TH23300Q9	9	TH25300Q9	9

Lift-Out Tray

MODEL #	A, B, IN. (MM)	MIN. IN. (MM)	DRAWER SIZE
TT625	6" (153mm)	11-1/4" (286mm)	#80
TT450	Less than 4" (102mm)	9-3/16" (233mm)	#65

Drawer Toolholder Supports - 25" (635mm)

MODEL #	DESCRIPTION	HEIGHT
DRPS02	Supports for HSK straight shank KM or CAPTO	2" (51mm)
DRPS03	¹ Supports for 30V	3" (76mm)
DRPS04	¹ Supports for 40V and 45V (pair)	4-1/4" (108mm)
DRPS05	¹ Supports for 50V (pair)	5-1/4" (133mm)
DRPS06	Supports to allow for longer retention knob lengths	6-1/4" (159mm)

¹Drawer toolholder supports assume that standard retention knobs with extensions of less than 1" (25mm) are used (V-flange tooling only)
²Height is measured from bottom of drawer to top of toolholder

CORNER DESK

- Provides remote working space and extra storage space for manuals and records
- Designed to complete a corner turn when cabinets are arranged in an "L" or square formation
- Desks are 44" (1118mm) high and occupy the space of two standard cabinets and one corner spacer
- Features include fluorescent light with switch and bookcase with two shelves (see bookcase section on page 86 for additional bookcase options)



Corner Desk

Corner Desk

MODEL #	DESCRIPTION
CDA58R	Right-Hand Corner Desk
CDA58L	Left-Hand Corner Desk
MLPT58R	Laminated Top for Right-Hand Desk
MLPT58L	Laminated Top for Left-Hand Desk

STRAIGHT DESK

- Provides writing surface and supervisory work areas
- Available in 30" (762mm) and 60" (1524mm) widths and 44" (1118mm) height
- Features include fluorescent light with switch and laminated writing surface with knockouts for wiring access



Straight Desk

Straight Desk

MODEL #	DESCRIPTION
SDA30	30" (762mm) Straight Desk
SDA60	60" (1524mm) Straight Desk
MLPT30	Laminated Top for Upper Shelf, 30" (762mm)
MLPT60	Laminated Top for Upper Shelf, 60" (1524mm)

MOBILE CONTROL CENTER

- Universal components: standard 245 cabinet, corner desk/bookcase, safety panel, and integral pallet base
- Easy to assemble in any configuration
- Well-lit workspace and counter surface around two sides
- Safety panel prevents chair roll-away and buffers noise
- Pallet base allows effortless relocation with forklift
- Available knocked down or fully assembled



SLOPE TOP DESK

Model # DST30 (For Standard Cabinet)
 Model # DST45 (For Extra-Wide Cabinet)
 Model # DST60 (For Double-Wide Cabinet)

- Designed for use where report or record-keeping space is limited
- Fits on top of standard size cabinet
- Equipped with pencil holder and clipboard clasp
- Hinged at rear, desktop opens to provide additional storage space beneath writing surface
- Lid support included to hold writing surface in open position



TYPE A STRAIGHT WORKSTATIONS

- These attractive, rugged workstations are designed to meet today's demanding benching requirements
- The modular characteristics of the workstations provide many different benching options. And when relocation becomes necessary, moving the modular workstation is easy
- Disassembly is simple, as is moving fully loaded cabinets
- And remember... You can always add to any modular workstation when expansion becomes necessary
- To meet your specific workstation needs, simply select the exact storage components and work surface that match your requirements
- Available in different heights, depths and widths



Type A

TYPE B CORNER WORKSTATIONS

- Vidmar® corner workstations fill a specific need in benching requirements for corner and right-angle configurations
- Wasted corner space is eliminated
- Cabinets, work surfaces, and a complete line of accessories flow at right angles for maximum operator efficiency and convenience
- Drawer storage is never more than a comfortable arm's length away. Right-angle capabilities now offer unlimited work center layouts in clusters configured face-to-face, back-to-back, or side-by-side to take full advantage of available space, lighting, and room layout.



Type B



A-1: 1-SEP1023AL, HT60, BL1751



A-2: 1-SEP1023AL, HT60, BL1751, BS360, ES330



A-3: 1-SEP1023AL, HT60, BL1751, BFS60



A-4: 1-SEP1023AL, HT60, BL1751, BFS60, BPFBS60, ES330



A-5: 1-SEP1023AL, 1-SEP1031AL, HT84



A-6: 1 SEP1023AL, 1-SEP1031AL, HT84, BS384, ES330



A-7: 1-SEP1023AL, 1-SEP1031AL, HT84, BFS84



A-8: 1-SEP1023AL, 1-SEP1031AL, HT84, BFS84, BPFBS84, ES330



A-9: 1-SEP1023AL, HT72, 2-BL1751



A-10: 1-SEP1023AL, HT72, 2-BL1751, BS372, ES330



A-11: 1-SEP1023AL, HT72, 2-BL1751, BFS72



A-12: 1-SEP1023AL, HT72, 2-BL1751, BFS72, BPFBS72, ES330



B-1: 1-SEP1023AL, 2-BL1751, HT90, HT60, SP



B-2: 1-SEP1023AL, 2-BL1751, HT90, HT60, SP, ES330, BS390, BS360



B-3: 1-SEP1023AL, 2-BL1751, HT90, HT60, SP, 2, BFS60, CBFS30



B-4: 1-SEP1023AL, 2-BL1751, HT90, HT60, SP, ES330, 2-BFS60, CBFS30, 2-BPFBS60, 2-BPFBS30



B-5: 1-SEP1023AL, 1-SEP1037AL, BL1751, HT90, HT60, SP



B-6: 1-SEP1023AL, 1-SEP1037AL, BL1751, HT90, HT60, SP, ES330, BS390, BS360



B-7: 1-SEP1023AL, 1-SEP1037AL, BL1751, HT90, HT60, SP, 2-BFS60, CBFS30



B-8: 1-SEP1023AL, 1-SEP1037AL, BL1751, HT90, HT60, SP, 2-BFS60, CBFS30, 2-BPFBS60, 2-BPFBS30

TYPE C HI-LO WORKSTATIONS

- Hi-lo workstations offer a wide variety of configurations with maximum storage capacity by using the full range of modular storage drawer cabinets with various work surface designs
- You may select the right combinations that meet your workstation requirements without being restricted by floor space allocations and materials to be stored or used in the workstation
- Drawers can be easily arranged so their labels, compartments, and contents are always facing the operator, in order to keep moving, reaching, and lifting to a minimum



Type C



C-1: 1-SEP3155AL, BL1751, HT60, HILO

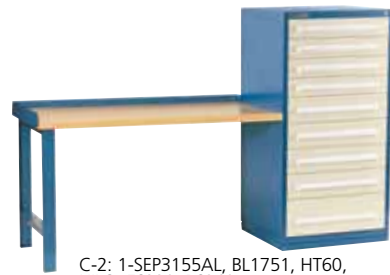

C-2: 1-SEP3155AL, BL1751, HT60, HILO, ES330, BS360



C-3: 1-SEP3155AL, BL1751, HT60, HILO, BFS60



C-4: 1-SEP3155AL, BL1751, HT60, HILO, BFS60, BPBFS60, ES330



C-5: 1-SEP1023AL, 1-SEP3155AL, HT60, HILO

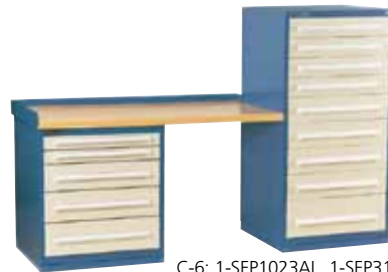

C-6: 1-SEP1023AL, 1-SEP3155AL, HT60, HILO, BS360, ES330



C-7: 1-SEP1023AL, 1-SEP3155AL, HT60, HILO, BFS60



C-8: 1-SEP1023AL, 1-SEP3155AL, HT60, HILO, BFS60, BPBFS60, ES330

TYPE D CENTER WORKSTATIONS

- This center cabinet configuration is ideal for two-person workstations where each worker uses common parts and supplies, or shares work in process
- Additional cabinets can be added so that each worker has parts and supplies specifically needed for an operation, and can draw on parts from the central, common storage cabinet
- As with all workstations, there's no need to bend or stoop to look into hidden shelves, because the heavy-duty Vidmar® drawers roll easily out of the cabinets into full view for maximum efficiency



Type D



D-1: 1-SEP1037AL, 1-SEP1037AL, 1-SEP1031AL, HT90, HT60, HILO



D-2: 1-SEP1037AL, 1-SEP1037AL, 1-SEP1031AL, HT90, HT60, HILO, BS390, BS360, ES330



D-3: 1-SEP1037AL, 1-SEP1037AL, 1-SEP1031AL, HT90, HT60, HILO, BFS90, BFS60



D-4: 1-SEP1037AL, 1-SEP1037AL, 1-SEP1031AL, HT90, HT60, HILO, BFS90, BFS60, BPBFS90, BPBFS60, ES330



D-5: 1-SEP3155AL, 2-HT60, 2-BL1751, 2-HILO

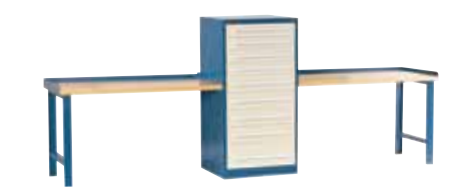

D-6: 1-SEP3155AL, 2-HT60, 2-BL1751, 2-HILO, 2-BS360, ES330

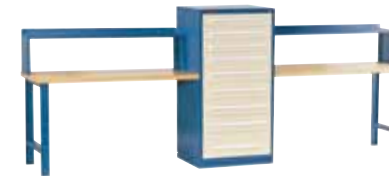

D-7: 1-SEP3155AL, 2-HT60, 2-BL1751, 2-HILO, 2-BFS60

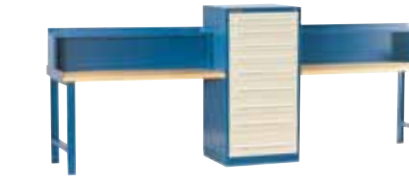

D-8: 1-SEP3155AL, 2-HT60, 2-BL1751, 2-HILO, 2-BFS60, 2-BPBFS60, ES330

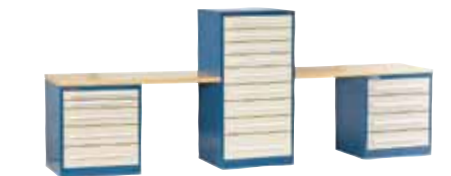

D-9: 1-SEP3155AL, 1-SEP1023AL, 1-SEP1031AL, 2-HT60, 2-HILO

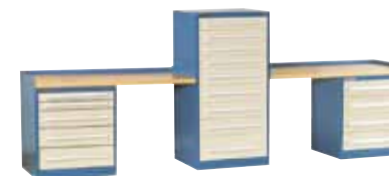

D-10: 1-SEP3155AL, 1-SEP1023AL, 1-SEP1031AL, 2-HT60, 2-BS360, ES330, 2-HILO



D-11: 1-SEP3155AL, 1-SEP1023AL, 1-SEP1031AL, 2-HT60, 2-BFS60, 2-HILO

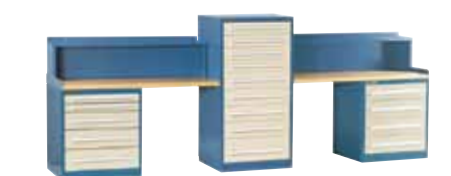

D-12: 1-SEP3155AL, 1-SEP1023AL, 1-SEP1031AL, 2-HT60, 2-BFS60, 2-BPBFS60, ES330, 2-HILO



OPEN BENCH LEGS

- Formed steel leg units predrilled for fastening

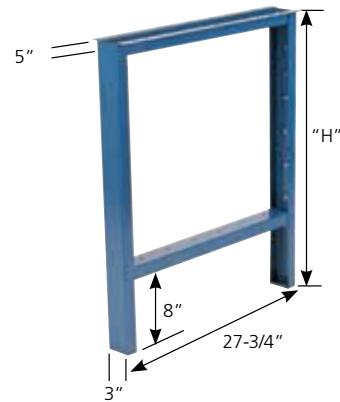

PANEL BENCH LEGS

- Combination of open bench legs and panels

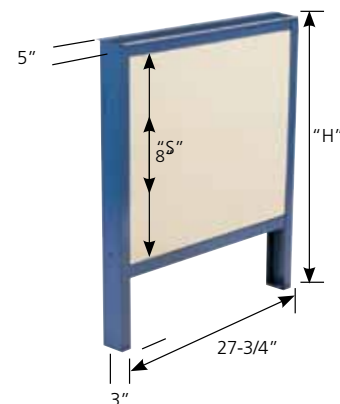

SIDE PANELS

- Can be easily installed into existing open bench legs

Open Bench Legs

MODEL #	DESCRIPTION	HEIGHT	
		IN.	MM
BL1351	For 135 Cab. with Pallet Feet	26.85"	(682mm)
BL1352	For 135 Cab. with HNF	24.72"	(628mm)
BL1353	For 135 Cab. with RB	29.85"	(758mm)
BL1354	For 135 Cab. with RB and HNF	27.72"	(704mm)
BL1355	For 135 Cab. with Channel Base	25.44"	(646mm)
BL1356	For 135 Cab. with MB, Plate Caster	28.45"	(723mm)
BL1551	For 155 Cab. with Pallet Feet	30.00"	(762mm)
BL1552*	For 155 Cab. with HNF	27.87"	(708mm)
BL1553	For 155 Cab. with RB	33.00"	(838mm)
BL1554	For 155 Cab. with RB and HNF	30.84"	(783mm)
BL1555	For 155 Cab. with Channel Base	28.62"	(727mm)
BL1556	For 155 Cab. with MB, Plate Caster	28.60"	(726mm)
BL1751	For 175 Cab. with Pallet Feet	33.15"	(842mm)
BL1752	For 175 Cab. with HNF	31.02"	(788mm)
BL1753	For 175 Cab. with RB	36.15"	(918mm)
BL1754	For 175 Cab. with RB and HNF	34.02"	(864mm)
BL1755	For 175 Cab. with Channel Base	31.77"	(807mm)
BL1756	For 175 Cab. with MB, Plate Caster	31.75"	(806mm)
BL2001	For 200 Cab. with Pallet Feet	37.09"	(942mm)
BL2002	For 200 Cab. with HNF	34.95"	(888mm)
BL2003	For 200 Cab. with RB	40.09"	(1018mm)
BL2004	For 200 Cab. with RB and HNF	37.95"	(964mm)
BL2005	For 200 Cab. with Channel Base	35.68"	(906mm)
BL2451	For 245 Cab. with Pallet Feet	44.17"	(1122mm)
BL2452	For 245 Cab. with HNF	42.04"	(1068mm)
BL2453	For 245 Cab. with RB	47.17"	(1198mm)
BL2454	For 245 Cab. with RB and HNF	45.01"	(1143mm)
BL2455	For 245 Cab. with Channel Base	42.76"	(1086mm)
BL2456	For 245 Cab. with MB, Plate Caster	42.77"	(1086mm)

Panel Bench Legs

MODEL #	DESCRIPTION	HEIGHT	
		IN.	MM
PBL1351	For 135 Cab. with Pallet Feet	26.76"	(680mm)
PBL1353	For 135 Cab. with RB	29.76"	(756mm)
PBL1551	For 155 Cab. with Pallet Feet	29.91"	(760mm)
PBL1553	For 155 Cab. with RB	32.91"	(836mm)
PBL1751	For 175 Cab. with Pallet Feet	33.06"	(840mm)
PBL1753	For 175 Cab. with RB	36.06"	(916mm)
PBL2001	For 200 Cab. with Pallet Feet	37.00"	(940mm)
PBL2003	For 200 Cab. with RB	40.00"	(1016mm)
PBL2451	For 245 Cab. with Pallet Feet	44.08"	(1119mm)
PBL2453	For 245 Cab. with RB	47.08"	(1195mm)

Side Panels

MODEL #	DESCRIPTION	HEIGHT	
		IN.	MM
BLS16	For use with BL1351	15.94"	(405mm)
BLS19	For use with BL1353 and BL1551	18.94"	(481mm)
BLS22	For use with BL1553 and BL1751	22.09"	(561mm)
BLS25	For use with BL1753	25.24"	(641mm)
BLS28	For use with BL2003	29.18"	(741mm)
BLS33	For use with BL2451	33.26"	(845mm)
BLS36	For use with BL2453	36.26"	(921mm)

STRINGER, FOOTREST, AND FOOTREST SHELVES

- Used between cabinets or between bench leg and cabinet
- Stringers and bench legs are predrilled



Stringer



Footrest



Footrest Shelf

Stringer

MODEL #	DESCRIPTION	WORKSTATION TOP SIZES IN. (MM)					
		60" (1524MM)	72" (1829MM)	84" (2134MM)	90" (2286MM)	96" (2438MM)	120" (3048MM)
STCCXXX	Std. Cabinet to Std. Cabinet	-	-	24	30	36	60
STBCXXX	Bench Leg to Std. Cabinet	30	42	54	60	66	90
STCCXXX	Sm. Version Cab. to Sm. Version Cab.	-	27	39	45	51	75
STBCXXX	Bench Leg to Sm. Version Cab.	37	49	61	67	73	97
STCCXXX	Std. Cabinet to Sm. Version Cab.	-	19	31	37	43	67
BLFRXX	Bench Leg to Bench Leg	60	72	84	90	96	120

Not available on corner workstations

Footrest

MODEL #	DESCRIPTION	WORKSTATION TOP SIZES IN. (MM)					
		60" (1524MM)	72" (1829MM)	84" (2134MM)	90" (2286MM)	96" (2438MM)	120" (3048MM)
FRCCXXX	Std. Cabinet to Std. Cabinet	-	-	024	030	036	060
FRBCXXX	Bench Leg to Std. Cabinet	030	042	054	060	066	090
FRCCXXX	Sm. Version Cab. to Sm. Version Cab.	-	027	039	045	051	075
FRBCXXX	Bench Leg to Sm. Version Cab.	037	049	061	067	073	097
FRCCXXX	Std. Cabinet to Sm. Version Cab.	-	019	031	037	043	097
BLFRXX	Bench Leg to Bench Leg	60	72	84	90	96	120

Not available on corner workstations

Footrest Shelf

MODEL #	DESCRIPTION	WORKSTATION TOP SIZES IN. (MM)					
		60" (1524MM)	72" (1829MM)	84" (2134MM)	90" (2286MM)	96" (2438MM)	120" (3048MM)
SHCCXXX	Std. Cabinet to Std. Cabinet	-	-	024	030	036	060
SHBCXXX	Bench Leg to Std. Cabinet	030	042	054	060	066	090
SHCCXXX	Sm. Version Cab. to Sm. Version Cab.	-	027	039	045	051	075
SHBCXXX	Bench Leg to Sm. Version Cab.	037	049	061	067	073	097
SHCCXXX	Std. Cabinet to Sm. Version Cab.	-	019	031	037	043	067
BLSXX	Bench Leg to Bench Leg	60	72	84	90	96	120

Not available on corner workstations

MODESTY PANELS

- Vidmar® technical benching modesty panels are lightweight steel panels used to completely enclose benching rear
- Modesty panels are predrilled for fastening (support braces included)



Modesty Panels

MODEL #	LENGTH	WORKSTATION TOP SIZE
AU-28-043-47	BL-CAB 43" (1092mm) W x 28" (711mm) H	48" (1219mm)
AU-28-055-47	BL-CAB 55" (1397mm) W x 28" (711mm) H	60" (1524mm)
AU-28-067-47	BL-CAB 67" (1701mm) W x 28" (711mm) H	72" (1829mm)
AU-31-043-47	BL-CAB 43" (1092mm) W x 31" (787mm) H	48" (1219mm)
AU-31-055-47	BL-CAB 55" (1397mm) W x 31" (787mm) H	60" (1524mm)
AU-31-067-47	BL-CAB 67" (1701mm) W x 31" (787mm) H	72" (1829mm)
AU-35-043-47	BL-CAB 43" (1092mm) W x 35" (889mm) H	48" (1219mm)
AU-35-055-47	BL-CAB 55" (1397mm) W x 35" (889mm) H	60" (1524mm)
AU-35-067-47	BL-CAB 67" (1701mm) W x 35" (889mm) H	72" (1829mm)
AU-28-026-33	CAB-CAB 26" (660mm) W x 28" (711mm) H	48" (1219mm)
AU-28-038-33	CAB-CAB 38" (965mm) W x 28" (711mm) H	60" (1524mm)
AU-28-050-33	CAB-CAB 50" (1270mm) W x 28" (711mm) H	72" (1829mm)
AU-31-026-33	CAB-CAB 26" (660mm) W x 31" (787mm) H	48" (1219mm)
AU-31-038-33	CAB-CAB 38" (965mm) W x 31" (787mm) H	60" (1524mm)
AU-31-050-33	CAB-CAB 50" (1270mm) W x 31" (787mm) H	72" (1829mm)
AU-35-026-33	CAB-CAB 26" (660mm) W x 35" (889mm) H	48" (1219mm)
AU-35-038-33	CAB-CAB 38" (965mm) W x 35" (889mm) H	60" (1524mm)
AU-35-050-33	CAB-CAB 50" (1270mm) W x 35" (889mm) H	72" (1829mm)

BACKSTOPS

- Flat steel panels used to enclose lower 3" (76mm) of rear of riser shelf
- Predrilled for fastening to riser shelf and bench top (same basic design as back panel, except only 3-3/4" [92mm] high)

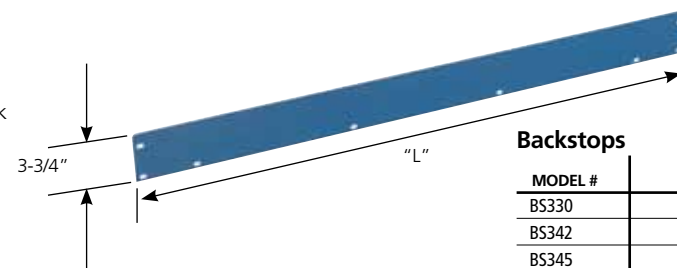

Backstops

MODEL #	IN.	LENGTH MM
BS330	30"	(762mm)
BS342	42"	(1067mm)
BS345	45"	(1143mm)
BS348	48"	(1219mm)
BS360	60"	(1524mm)
BS372	72"	(1829mm)
BS384	84"	(2134mm)
BS396	96"	(2438mm)
BS3120	120"	(3048mm)

END STOPS

- Flat steel panels with rear portions formed and pierced for attachment to backstops and/or riser shelves
- Supplied in a pair for left and right ends of bench unit

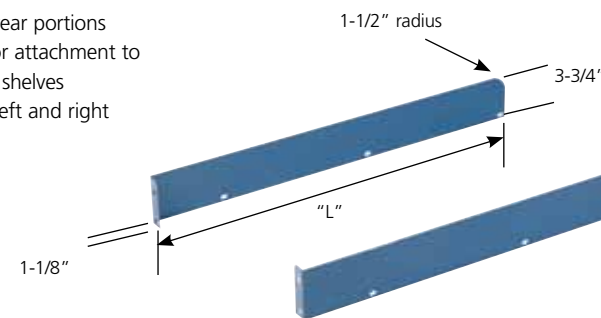

End Stops

MODEL #	IN.	LENGTH MM
ES324	24"	(610mm)
ES328	27-3/4"	(705mm)
ES330	30"	(762mm)
ES336	36"	(914mm)

BENCH RISER SHELVES/ CORNER RISER SHELVES (A, B)

- Ideal for getting tools, test, and other equipment off work surface
- 12" (305mm) deep
- Available in fixed 14" (356mm) height or adjustable height from 12" to 22" (305mm to 559mm)

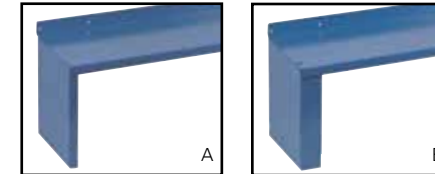

Fixed Height Bench Riser Shelves/Corner Riser Shelves (A)

MODEL #	FIXED HEIGHT	SHELF MATERIAL	POWER	CORNER RISER MODEL #
*BFS30, 36, 42, 48, 54, 60, 72, 84, 96	12" x 14" (305mm x 356mm)	Steel	See Electrical Outlet Strip Chart	CBFS30
*BFH30, 36, 42, 48, 54, 60, 72, 84, 96	12" x 14" (305mm x 356mm)	Ash Hardwood (add 1-1/4" [32mm] to height)	—	CBFH30

*Note: To order back panels (fixed risers only), use BPFBS 30/36/42/48/54/60/72/84/96 for steel and hardwood shelves

Adjustable Height Bench Riser Shelves/Corner Riser Shelves (B)

MODEL #	ADJUSTABLE HEIGHT	SHELF MATERIAL	POWER	CORNER RISER MODEL #
*BAS30, 36, 42, 48, 54, 60, 72, 84, 96	12" x 12"-22" (305mm x 305mm-559mm)	Steel	See Electrical Outlet Strip Chart	CBAS30
	See WAH below	Hardwood	See CWAH30 below	

*Note: To order back panels (fixed risers only), use BPFBS 30/36/42/48/54/60/72/84/96 for steel and hardwood shelves

ELECTRICAL OUTLET STRIPS AND LIGHTS

- Attach to the face or rear of a bench riser, a work surface shelf, or to a backstop located at the rear of a worksurface
- Part numbers ending in P are available in silver gray, enamel finish, prewired with plug; part numbers not ending in P are beige (with wiring instructions)
- Prewired strips are less than 2" (51mm) square, have a 15 amp circuit breaker, a snap-clip mounting system, and are UL-listed and CSA Certified*
- Fluorescent lights are available in lengths of 18", 36" and 48"



Notes: Power to workstation should be wired through GFCI receptacle. Factory installation not available for electrical outlet strips.

* Bench accessories are not predrilled for electrical outlet strips

Electrical Outlet Strips and Lights

MODEL #	# OF OUTLETS	LENGTH	
		IN.	MM
Electrical Outlet Strips			
EOS09P	4	9"	(229mm)
EOS24P	8	24"	(610mm)
EOS48P	8	48"	(1219mm)
EOS72P	9	72"	(1829mm)
EOS36	6	36"	(914mm)
EOS60	5	60"	(1524mm)
EOS72	6	72"	(1829mm)
Lights			
FL01807200		18"	(457mm)
FL03607200		36"	(914mm)
FL04807200		48"	(1219mm)

WORKSTATION RISER SHELVES/CORNER RISER SHELVES (C, D)

- Available in fixed 15" (381mm) height or adjustable height from 12" to 22" (305mm to 559mm)
- Power (110V) can be supplied to workstation through uprights, shelves, or both (options below)
- 12" (305mm) deep



Power support shown

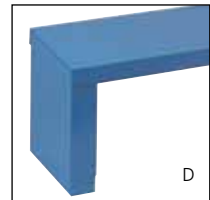

Non-power support shown

Fixed Height Workstation Riser Shelves/Corner Riser Shelves (C)

MODEL #	FIXED HEIGHT	SHELF MATERIAL	POWER	CORNER RISER MODEL #
*WFS30, 36, 42, 48, 54, 60, 72, 84, 96	12" x 15" (305mm x 381mm)	Steel	None	CWFS30
*WFS30P, 36P, 42P, 48P, 54P, 60P, 72P, 84P, 96P	12" x 15" (305mm x 381mm)	Steel	Shelf and Supports (with GFCI)	CWFS30
*WFH30, 36, 42, 48, 54, 60, 72, 84, 96	12" x 15" (305mm x 381mm)	Hardwood	None	CWFH30
*WFH30P, 36P, 42P, 48P, 54P, 60P, 72P, 84P, 96P	12" x 15" (305mm x 381mm)	Hardwood	Supports Only (with GFCI)	CWFH30

*Note: To order back panels (fixed risers only), use BPWFS 30/36/42/48/54/60/72/84/96 for steel surfaces, and BPWFC 30/36/42/48/54/60/72/84/96 for hardwood surfaces

Adjustable Height Workstation Riser Shelves/Corner Riser Shelves (D)

MODEL #	ADJUSTABLE HEIGHT	SHELF MATERIAL	POWER	CORNER RISER MODEL #
WAS30, 36, 42, 48, 54, 60, 72, 84, 96	12" x 12"-22" (305mm x 305mm-559mm)	Steel	None	CWAS30
WAS30P, 36P, 42P, 48P, 54P, 60P, 72P, 84P, 96P	12" x 12"-22" (305mm x 305mm-559mm)	Steel	Shelf Only (with GFCI)	CWAS30
WAH30, 36, 42, 48, 54, 60, 72, 84, 96	12" x 12"-22" (305mm x 305mm-559mm)	Hardwood (add 1/4" [6mm] to height)	See Electrical Outlet Strip Chart If Power Is Required	CWAH30

BACK PANELS (A, B)

- Formed steel panel used to completely enclose rear of riser shelf
- Predrilled for fastening to riser shelf and bench top
- Support braces supplied with riser shelf are not used when optional back panel is utilized

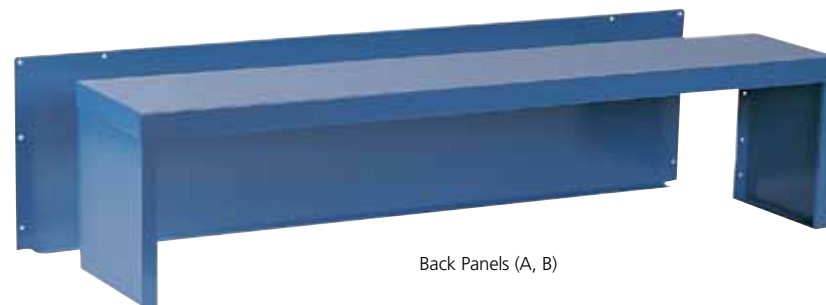

Back Panels (A, B)

Back Panels: Fixed Bench Risers (A) (Use with BFS Risers)

MODEL #	DESCRIPTION	LENGTH	
		IN.	MM
BPBFS30	Fixed Steel	30"	(762mm)
BPBFS36	Fixed Steel	36"	(914mm)
BPBFS42	Fixed Steel	42"	(1067mm)
BPBFS48	Fixed Steel	48"	(1219mm)
BPBFS54	Fixed Steel	54"	(1372mm)
BPBFS60	Fixed Steel	60"	(1524mm)
BPBFS72	Fixed Steel	72"	(1829mm)
BPBFS84	Fixed Steel	84"	(2134mm)
BPBFS96	Fixed Steel	96"	(2438mm)
BPBFS30	Fixed Hardwood	30"	(762mm)
BPBFS36	Fixed Hardwood	36"	(914mm)
BPBFS42	Fixed Hardwood	42"	(1067mm)
BPBFS48	Fixed Hardwood	48"	(1219mm)
BPBFS54	Fixed Hardwood	54"	(1372mm)
BPBFS60	Fixed Hardwood	60"	(1524mm)
BPBFS72	Fixed Hardwood	72"	(1829mm)
BPBFS84	Fixed Hardwood	84"	(2134mm)
BPBFS96	Fixed Hardwood	96"	(2438mm)

Back Panels: Workstation Risers (B)

MODEL #	DESCRIPTION	LENGTH	
		IN.	MM
BPWFS30	Fixed Steel	30"	(762mm)
BPWFS36	Fixed Steel	36"	(914mm)
BPWFS42	Fixed Steel	42"	(1067mm)
BPWFS48	Fixed Steel	48"	(1219mm)
BPWFS54	Fixed Steel	54"	(1372mm)
BPWFS60	Fixed Steel	60"	(1524mm)
BPWFS72	Fixed Steel	72"	(1829mm)
BPWFS84	Fixed Steel	84"	(2134mm)
BPWFS96	Fixed Steel	96"	(2438mm)
BPWFCXX30	Fixed Hardwood	30"	(762mm)
BPWFCXX36	Fixed Hardwood	36"	(914mm)
BPWFCXX42	Fixed Hardwood	42"	(1067mm)
BPWFCXX48	Fixed Hardwood	48"	(1219mm)
BPWFCXX54	Fixed Hardwood	54"	(1372mm)
BPWFCXX60	Fixed Hardwood	60"	(1524mm)
BPWFCXX72	Fixed Hardwood	72"	(1829mm)
BPWFCXX84	Fixed Hardwood	84"	(2134mm)
BPWFCXX96	Fixed Hardwood	96"	(2438mm)

SPLICE KITS (NOT PICTURED)

Model # SP

28" (711mm) long

- Includes predrilled metal plate and attaching hardware
- Used when joining two tops to form a corner workstation



HI-LO MOUNTING KIT (NOT PICTURED)

Model# HILO

- Includes a painted predrilled bracket and hardware
- Used for mounting a worksurface to the side of a cabinet



WORK SURFACES



Note: Other sizes available



Customize your workstation with accessories

DESCRIPTION, IN. (MM)	CONSTRUCTION	APPLICATION	SPANS IN. (MM)	MODEL # — TOP LENGTHS, IN. (MM)									
				30" (762MM)	45" (1143MM)	48" (1219MM)	60" (1524MM)	72" (1829MM)	84" (2134MM)	90" (2286MM)	96" (2438MM)	120" (3048MM)	
30" (762MM) DEEP (FRONT TO BACK) WORK SURFACES													
1-1/2" (38mm) Thick, Plastic Top	Laminate top over particle board core	Light-duty benching applications	72" (1829mm)	PL30	PL45	—	PL60	PL72	PL84	PL90	PL96	—	
1-1/2" (38mm) Thick, Radius-Edge Plastic Top	Laminate top over particle board core	Light-duty benching applications	72" (1829mm)	—	—	—	PLR60	PLR72	PLR84	PLR90	PLR96	—	
1-3/4" (44mm) Thick, Shop Top	High-density resin core with particle board surface	Heavy-duty workbench applications	72" (1829mm)	WT30	WT45	—	WT60	WT72	WT84	WT90	WT96	—	
1-3/4" (44mm) Thick, Steel Top	Painted steel top with enclosed ends	Heavy-duty workbench	96" (2438mm)	ST30	ST45	—	ST60	ST72	ST84	ST90	ST96	—	
1-3/4" (44mm) Thick, Hardwood Top	Solid, hardwood	Heavy-duty	96" (2438mm)	HT30	HT45	—	HT60	HT72	HT84	HT90	HT96	HT120	
27-3/4" (705MM) DEEP CABINET COVERS													
3/8" (22mm) Stainless Steel Surface	Fits over cabinet	Cabinet cover	none	CT-27-030-30	CT-27-045-30	—	CT-27-060-30	—	—	CT-27-090-30	—	CT-27-120-30	
7/8" (22mm) Stainless Steel Surface to Fit Over MLPT	Fits over particle board	Cabinet cover	none	SIS30	SIS45	—	SIS60	SIS72	SIS84	SIS90	SIS96	SIS120	
1/4" (6mm) Steel Plate Top	Fits over any surface, painted	Cabinet cover, heavy-duty	none	SPT014	—	—	SPT024	—	—	—	—	—	
1/8" (3mm) Steel Plate Top	Fits over any surface, painted	Cabinet cover, heavy-duty	none	SPT018	—	—	SPT028	—	—	—	—	—	
OTHER TOPS													
1-3/4" (44mm) Thick, 36" (914mm) Deep, Full Radius, Dissipative Top	Laminate over particle board	StaticGard™ applications	60" (1524mm)	—	—	—	SGWS60361	SGWS72361	SGWS84361	SGWS90361	SGWS96361	—	
1-3/4" (44mm) Thick, 30" (762mm) Deep Stainless Steel Surface to Fit Over Hardwood Top	Formed stainless steel	Cabinet cover	none	SIS30M	SIS45M	—	SIS60M	SIS72M	SIS84M	SIS90M	SIS96M	—	
1-1/2" (38mm) Thick, 30" (762mm) and 36" (914mm) Deep Stainless Top, 1/4" (6mm) Radius Edge on Four Sides	Stainless steel surface, premium MDF core with melamine backing	Heavy-duty workbench applications	72" (1829mm)	SS-30X30X150 SS-36X30X150	SS-45X30X150 SS-45X36X150	SS-48X30X150 SS-48X36X150	SS-60X30X150 SS-60X36X150	SS-72X30X150 SS-72X36X150	SS-84X30X150 SS-84X36X150	SS-90X30X150 SS-90X36X150	SS-96X30X150 SS-96X36X150	SS-120X30X150 SS-120X36X150	

*Quick Ship products

BOOKCASE

- Standard bookcase is 30" (762mm) wide—the dimensions of a standard cabinet—and 14" (356mm) deep
- Bookcases are also available in 45" (1143mm) and 60" (1524mm) widths
- Secured bookcase options available
- Shelves are adjustable on 2" Centers



LOCK FOR HINGED DOORS

Model # SDLBKAXX

Replace XX with desired height:
17" (432mm), 27" (684mm),
30" (762mm), 33" (838mm),
37" (940mm) and 44" (1118mm)

Bookcase

MODEL #	DESCRIPTION	HEIGHT	# OF SHELVES
BKA44	Standard – 30" W x 14" D	44"	2
BKA37	Standard – 30" W x 14" D	37"	1
BKA33	Standard – 30" W x 14" D	33"	1
BKA30	Standard – 30" w x 14" D	30"	1
BKA27	Standard – 30" w x 14" D	27"	1
BKA17	Standard – 30" w x 14" D	17"	None

*Add prefix of "XW" for 45" wide bookcase or "DW" for 60" wide bookcase (i.e., XWBKA44; etc.)

* Small Version (SV) bookcase is available, add SV in front of the bookcase model #

Bookcase Options

MODEL #	DESCRIPTION	BATTENS	DOUBLE-HINGED STEEL DOORS	BYPASSING CLEAR PLASTIC	BYPASSING STEEL
BKAXX*	Standard	BT300	SDDBKAXX	PSDBKAXX	SSDBKAXX
XWBKAXX*	Extra-Wide	BTXW300	N/A	N/A	N/A
DWBKAXX*	Double-Wide	BTDW300	N/A	N/A	N/A
BS30	Bookcase Shelf – 30"	—	—	—	—
BS45	Bookcase Shelf – 45"	—	—	—	—
BS60	Bookcase Shelf – 60"	—	—	—	—
MLPT30	Laminated Top – 30"	—	—	—	—
MLPT45	Laminated Top – 45"	—	—	—	—
MLPT60	Laminated Top – 60"	—	—	—	—

*Substitute height (44, 37, 33, 30, 27, 17) for "XX" in model number

BOOKCASE RISER

- Specially made to support bookcases



Bookcase Riser

MODEL #	DESCRIPTION	HEIGHT		LENGTH		APPLICATION
		IN.	MM	IN.	MM	
BKR3014	Riser	14"	(356mm)	30"	(762mm)	One Standard Width Bookcase
BKR3021	Riser	21"	(533mm)	30"	(762mm)	One Standard Width Bookcase
BKR3024	Riser	24"	(610mm)	30"	(762mm)	One Standard Width Bookcase
BKR4514	Riser	14"	(356mm)	45"	(1143mm)	One Extra-Wide Bookcase
BKR4521	Riser	21"	(533mm)	45"	(1143mm)	One Extra-Wide Bookcase
BKR4524	Riser	24"	(610mm)	45"	(1143mm)	One Extra-Wide Bookcase
BKR6014	Riser	14"	(356mm)	60"	(1524mm)	One Double-Wide or Two Standard Bookcases
BKR6021	Riser	21"	(533mm)	60"	(1524mm)	One Double-Wide or Two Standard Bookcases
BKR6024	Riser	24"	(610mm)	60"	(1524mm)	One Double-Wide or Two Standard Bookcases
BKR9014	Riser	14"	(356mm)	90"	(2286mm)	Three Standard, Two Extra-Wide, or One Double-Wide and One Standard Bookcase
BKR9021	Riser	21"	(533mm)	90"	(2286mm)	Three Standard, Two Extra-Wide, or One Double-Wide and One Standard Bookcase
BKR9024	Riser	24"	(610mm)	90"	(2286mm)	Three Standard, Two Extra-Wide, or One Double-Wide and One Standard Bookcase

UNDER-BENCH PRECONFIGURED CABINETS

Available in six footprints:

1. Standard - 30" W x 27-3/4" D (UB0040, UB0060, UB0090, UB0110)
2. Shallow Depth - 30" W x 21-3/8" D (LWUB0040, LWUB0060, LWUB0090, LWUB0110)
3. Small Version - 22-1/2" W x 27-3/4" D (SVUB0040, SVUB0060, SVUB0090, SVUB0110)
4. Extra-Wide - 45" W x 27-3/4" D (XWUB0040, XWUB0060, XWUB0090, XWUB0110)
5. Extra-Wide Shallow Depth - 45" W x 21-3/8" D (XLUB0040, XLUB0060, XLUB0090, XLUB0110)
6. Double-Wide - 60" W x 27-3/4" D (DWUB0040, DWUB0060, DWUB0090, DWUB0110)

- Ideal for suspending from hardwood work surfaces
- Provides same durable storage capabilities as full-size Vidmar® cabinets
- Under-Bench cabinets allow for same drawer modularity as conventional cabinets (total drawer "points" must equal cabinet model number)



Under-Bench Preconfigured Cabinets

MODEL #	# & TYPE OF DRAWERS	CABINET HEIGHT	
		IN.	MM
UB40202	2 of #20	9-3/4"	(248mm)
UB40401	1 of #40	9-3/4"	(248mm)
UB60203	3 of #20	12-7/8"	(372mm)
UB60302	2 of #30	12-7/8"	(372mm)
UB60201401	1 of #20, 1 of #40	12-7/8"	(372mm)
UB60601	1 of #60	—	—

HOUSING MODEL	HEIGHT
40	9-3/4" (248mm)
60	12-7/8" (372mm)
90	17-5/8" (448mm)
110	20-3/4" (527mm)



CABINETS

- The cabinet is the cornerstone of a Vidmar® technical bench
- All cabinets have flush fronts and recessed drawer pulls
- All cabinets have a 16-1/2" (419mm) W x 28-1/4" (717mm) D footprint
- Three heights are available: 27-7/8" (711mm); 31" (787mm) and 35" (899mm) to meet your individual ergonomic needs
- Cabinet doors are also available with adjustable cabinet shelves



27-7/8" (711MM) DESK HEIGHT PRECONFIGURED CABINETS

PSTB28008 Model 8

Desk Height
27-7/8" (711mm) H
16-1/2" (419mm) W
28-1/4" (717mm) D



TB2801A
4 Drawers
28 Compartments
Usable Drawer Height
2-3/4" (69mm)
5-7/8" (149mm)
12-3/16" (309mm)

TB2802A
4 Drawers
24 Compartments
Usable Drawer Height
2-3/4" (69mm)
5-7/8" (149mm)
9" (229mm)

TB2803A
6 Drawers
44 Compartments
Usable Drawer Height
2-3/4" (69mm)
5-7/8" (149mm)



TB2805A
2 Drawers
Usable Drawer Height
12-3/16" (309mm)

TB2806A
4 Drawers
20 Compartments
Usable Drawer Height
5-7/8" (149mm)

TB2807A
1 Drawer
4 Compartments
1 Door (Right Hinge Shown)
1 Bottom Pan
Usable Drawer Height
5-7/8" (149mm)

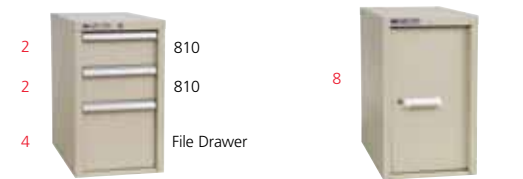

TB2804A
3 Drawers
12 Compartments
Usable Drawer Height
5-7/8" (149mm)
12-3/16" (309mm)

TB2808A
1 Shelf and
1 Door (Right Hinge Shown)
1 Bottom Pan

31" (787MM) TABLE HEIGHT PRECONFIGURED CABINETS

PSTB31009 MODEL 9

TABLE HEIGHT
31" (787mm) H
16-1/2" (419mm) W
28-1/4" (717mm) D



TB3101A
5 Drawers
32 Compartments
Usable Drawer Height
2-3/4" (69mm)
5-7/8" (149mm)
12-3/16" (309mm)

TB3102A
5 Drawers
38 Compartments
Usable Drawer Height
2-3/4" (69mm)
5-7/8" (149mm)

TB3103A
5 Drawers
32 Compartments
Usable Drawer Height
2-3/4" (69mm)
5-7/8" (149mm)
9" (229mm)



TB3104A
1 Drawer
4 Compartments
1 Shelf and 1 Door (Right Hinge Shown)
1 Bottom Pan
Usable Drawer Height
5-7/8" (149mm)

TB3105A
3 Drawers
4 Compartments
Usable Drawer Height
2-3/4" (69mm)
12-3/16" (309mm)

35" (899MM) BENCH HEIGHT PRECONFIGURED CABINETS

PSTB350010 MODEL 10

BENCH HEIGHT
35" (899mm) H
16-1/2" (419mm) W
28-1/4" (717mm) D



TB3501A
5 Drawers
32 Compartments
Usable Drawer Height
5-7/8" (149mm)

TB3502A
3 Drawers
4 Compartments
Usable Drawer Height
5-7/8" (149mm)
12-3/16" (309mm)

TB3503A
5 Drawers
26 Compartments
Usable Drawer Height
2-3/4" (69mm)
5-7/8" (149mm)
9" (229mm)

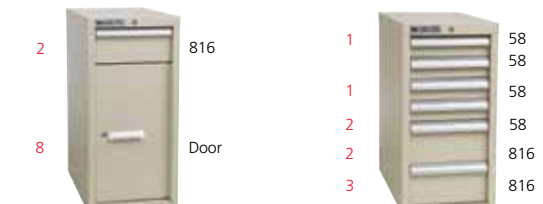

TB3504A
1 Drawer
4 Compartments
1 Shelf and 1 Door (Right Hinge Shown)
1 Bottom Pan
Usable Drawer Height
5-7/8" (149mm)

TB3505A
6 Drawers
36 Compartments
Usable Drawer Height
5-7/8" (149mm)
9" (229mm)



PSTB420012 Model 12

Bench Height
42" (1.1m) H
16-1/2" (419mm) W
28-1/4" (717mm) D

TECHNICAL BENCH DRAWERS

- Each Vidmar® technical bench cabinet drawer carries a load capacity of 200 lbs.
- Each drawer has 1955cm² of storage space available in four drawer heights: 2-3/4" (60mm), 5-7/8" (149mm), 9" (229mm), and 12-3/16" (309mm)
- Each drawer is equipped with 200 lbs. rated ball bearing slides for smooth, quiet operation
- Each drawer can be divided with full-depth, Vidmar® partitions and dividers
- Five standard interior loading diagrams are available. Partitions and dividers are factory configured and installed
- The larger drawer unit (PSTB04) can hold file folders without additional hardware
- Recessed drawer pulls are designed to accept 1-1/4" (33mm) labels with 3/4" (19mm) font or common P-Touch® labels for easy readability

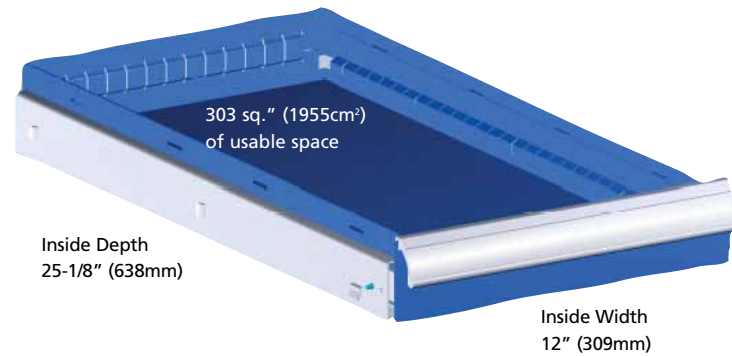

Drawers

MODEL #	USABLE HEIGHT		SIDE WALL HEIGHT	
	IN.	MM	IN.	MM
PSTB01	2-3/4"	(69mm)	2-5/8"	(66mm)
PSTB02	5-7/8"	(149mm)	5"	(127mm)
PSTB03	9"	(229mm)	8"	(203mm)
PSTB04	12-3/16"	(309mm)	9-1/2"	(241mm)

DRAWER HEIGHT

- Each drawer has 303 sq in. (1955 cm²) of usable space 25-1/8" (638mm) inside depth x 12" (309mm) inside width
- Drawer selection by model number must add up to the cabinet height



LDPSTB88
8 Compartments
(4) 5-1/2" x 6-1/4"
(140mm x 159mm)
(4) 6-1/4" x 6-1/4"
(159mm x 159mm)



LDPSTB510
9 Compartments
(6) 4" x 8-5/8"
(102mm x 219mm)
(3) 4" x 7-7/8"
(102mm x 200mm)



LDPSTB810
6 Compartments
(2) 5-1/2" x 8-5/8"
(140mm x 219mm)
(1) 5-1/2" x 7-7/8"
(140mm x 200mm)
(2) 6-1/4" x 8-5/8"
(159mm x 219mm)
(1) 6-1/4" x 7-7/8"
(159mm x 200mm)



LDPSTB58
12 Compartments
(12) 4" x 6-1/4"
(102mm x 159mm)



LDPSTB816
4 Compartments
(2) 5-1/2" x 12-1/2"
(140mm x 318mm)
(2) 6-1/4" x 12-1/2"
(159mm x 318mm)

RECESSED BASES & BASE EXTENSIONS

- Vidmar® technical benching recessed bases (3" H) and base extensions (2" H) provide employees with additional toe space



Base Extensions

MODEL #	DESCRIPTION	HEIGHT
PSTBKP1	Stainless Steel Kick Plate	7" (177mm)
PSTBRB1	Recessed Base	3" (76mm)
PSTNRB1	Base Extension	2" (50mm)

ADDITIONAL TECHNICAL BENCHING ACCESSORIES

- Includes lock kits, mobile caster kits, bottom shelves, bottom pans, and right-hand-only and left-hand-only cabinet doors



Additional Accessories

MODEL #	DESCRIPTION	HEIGHT
SL10TB	Lock Kit	
MB2HRTBS	2" (51mm) Mobile Castor Kit	3-1/4" (83mm)
PSTBCS20	200 lbs. Bottom Shelf	—
PSTBBP20	200 lbs. Bottom Pan	—

Doors

MODEL #	DESCRIPTION	HEIGHT
PSTBSD06	LH or RH Door Only	19" (480mm)
PSTBSD07	LH or RH Door Only	22" (560mm)
PSTBSD08	LH or RH Door Only	25-1/4" (640mm)
PSTBSD09	LH or RH Door Only	28-3/8" (720mm)
PSTBSD10	LH or RH Door Only	31-1/2" (800mm)
PSTBSD12	LH or RH Door Only	42" (1067mm)

VIDMAR® WORKBENCH ACCESSORY SYSTEM FEATURES

Vidmar Workbench Accessory System benefits include:

- Greater productivity and efficiency
- Reduced strain, increased ergonomic ease
- Workstations equipped to exactly suit your needs
- Properly illuminated work area
- Maximum available workspace

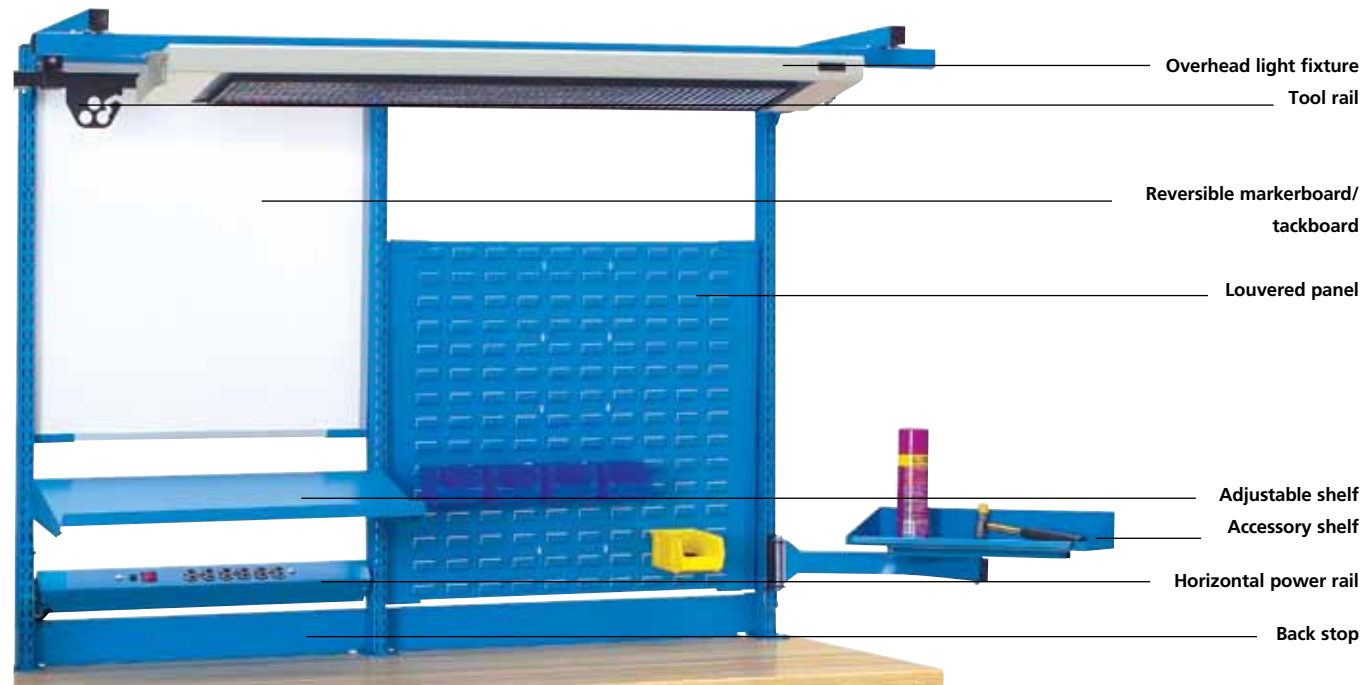

SYSTEM FRAMES

- Building your ideal Vidmar® workbench accessory system is an easy process
- Simply select the frames (starters and adders) that fit your worksurface width, then pick accessories of corresponding widths to mount on the frames
- Accessories are easily moved and repositioned as your needs change

Surface-Mount Frames

- Frames are sturdy, made of heavy-gauge steel, and are notched front and back at 1" increments for mounting accessories
- Starter frames consist of 2 upright posts and a horizontal rail
- Adder section consist of an additional upright and horizontal rail. Uprights are available in heights of 30" and 48", and 6 widths
- Foot plate is 2 3/4" x 4"
- Specify color from chart on back cover

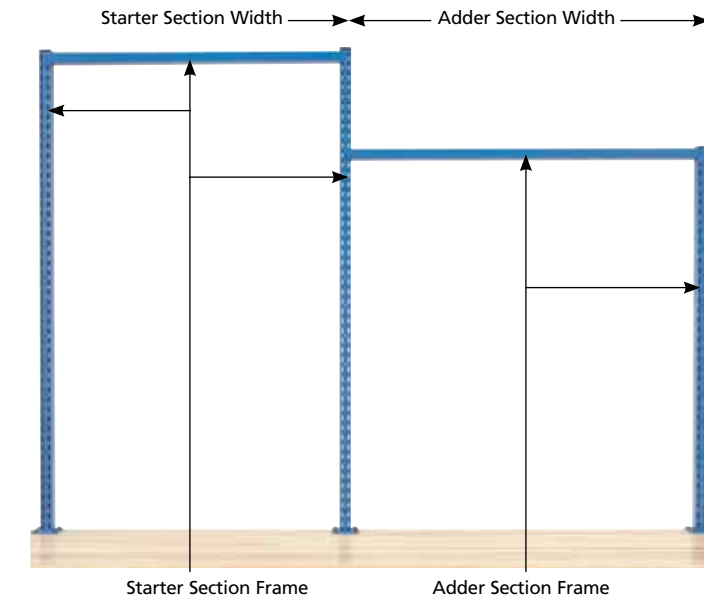

Available Widths of Frame Systems

The widths below represent measurements from frame center to frame center. Uprights are 1 3/16" wide.

Using 1 Section

SECTION WIDTH (CENTER-TO-CENTER)	OVERALL WIDTH (FOOT-TO-FOOT)	MINIMUM WORK-SURFACE LENGTH	INSIDE USEABLE WIDTH
24"	26 3/4"	30"	22 3/4"
30"	32 3/4"	36"	28 3/4"
36"	38 3/4"	42"	34 3/4"
42"	44 3/4"	48"	40 3/4"
48"	50 3/4"	54"	46 3/4"
60"	62 3/4"	66"	58 3/4"

Using 1 Starter and 1 Adder Section

SECTION WIDTH (CENTER-TO-CENTER)	OVERALL WIDTH	MINIMUM WORKSURFACE LENGTH (FOOT-TO-FOOT)
24" + 24"	50 3/4"	54"
24" + 30"	56 3/4"	60"
24" + 36"	62 3/4"	66"
24" + 42"	68 3/4"	72"
24" + 48"	74 3/4"	78"
24" + 60"	86 3/4"	90"
30" + 30"	62 3/4"	66"
30" + 36"	68 3/4"	72"
30" + 42"	74 3/4"	78"
30" + 48"	80 3/4"	84"
30" + 60"	92 3/4"	96"
36" + 36"	74 3/4"	78"
36" + 42"	80 3/4"	84"
36" + 48"	86 3/4"	90"
36" + 60"	98 3/4"	102"
42" + 42"	86 3/4"	90"
42" + 48"	92 3/4"	96"
42" + 60"	104 3/4"	108"
48" + 48"	98 3/4"	102"
48" + 60"	110 3/4"	114"
60" + 60"	122 3/4"	126"

30" High Surface-Mount Frames

MODEL NO.	SEC. WIDTH CENTER-TO-CENTER
STARTER SET	
V-NXF/SM2430	24"
V-NXF/SM3030	30"
V-NXF/SM3630	36"
V-NXF/SM4230	42"
V-NXF/SM4830	48"
V-NXF/SM6030	60"

MODEL NO.	SEC. WIDTH CENTER-TO-CENTER
ADDER SET	
V-NXF/SM2430A	24"
V-NXF/SM3030A	30"
V-NXF/SM3630A	36"
V-NXF/SM4230A	42"
V-NXF/SM4830A	48"
V-NXF/SM6030A	60"

48" High Surface-Mount Frames

MODEL NO.	SEC. WIDTH CENTER-TO-CENTER
STARTER SET	
V-NXF/SM2448	24"
V-NXF/SM3048	30"
V-NXF/SM3648	36"
V-NXF/SM4248	42"
V-NXF/SM4848	48"
V-NXF/SM6048	60"

MODEL NO.	SEC. WIDTH CENTER-TO-CENTER
ADDER SET	
V-NXF/SM2448A	24"
V-NXF/SM3048A	30"
V-NXF/SM3648A	36"
V-NXF/SM4248A	42"
V-NXF/SM4848A	48"
V-NXF/SM6048A	60"

SHELVES

Adjustable Shelves

- Adjustable, heavy-gauge steel shelves can be mounted parallel to the worksurface or at a 15° angle for easy, ergonomic access
- Shelves have a 100 lb. weight capacity for evenly distributed loads
- Shelves are reversible, with the lip either at the front, or at the rear to act as a back stop

Shelf Dividers

- Steel dividers fit over the edge of adjustable shelf when shelf is mounted at 0°
- Base of divider can be either to left or right of divider upright
- Painted to match shelf

Adjustable Shelves Without Lip

- Adjustable steel shelf has a 100 lb. weight capacity
- Supports are attached through a simple double-notch system that insert into slots on the uprights
- Available in depths of 12" and 15"
- Prepunched holes accept vertical wire dividers (see below)

Vertical Wire Dividers for Adjustable Shelves Without Lip

- Dividers are 1/4" diameter galvanized wire that fit into prepunched holes in the shelf
- No hardware required
- Depth must match shelf depth



Adjustable Shelves

MODEL NO.	SHELF WID.	SEC. WID.
12" DEEP		
V-NXS/A2412L	23 1/2"	24"
V-NXS/A3012L	29 1/2"	30"
V-NXS/A3612L	35 1/2"	36"
V-NXS/A4212L	41 1/2"	42"
V-NXS/A4812L	47 1/2"	48"
V-NXS/A6012L	59 1/2"	60"
15" DEEP		
V-NXS/A2415L	23 1/2"	24"
V-NXS/A3015L	29 1/2"	30"
V-NXS/A3615L	35 1/2"	36"
V-NXS/A4215L	41 1/2"	42"
V-NXS/A4815L	47 1/2"	48"
V-NXS/A6015L	59 1/2"	60"



Adjustable Shelves Without Lip

MODEL NO.	SHELF WIDTH
12" DEEP	
V-NXS/A2412D	24"
V-NXS/A3012D	30"
V-NXS/A3612D	36"
V-NXS/A4212D	42"
V-NXS/A4812D	48"
V-NXS/A6012D	60"
15" DEEP	
V-NXS/A2415D	24"
V-NXS/A3015D	30"
V-NXS/A3615D	36"
V-NXS/A4215D	42"
V-NXS/A4815D	48"
V-NXS/A6015D	60"



Shelf Dividers

MODEL NO.	HEIGHT
FOR 12" DEEP ADJUSTABLE SHELVES	
V-NXS/MD100-12/L	4"
V-NXS/MD100-12/R	4"
V-NXS/MD150-12/L	6"
V-NXS/MD150-12/R	6"
V-NXS/MD200-12/L	8"
V-NXS/MD200-12/R	8"
FOR 15" DEEP ADJUSTABLE SHELVES	
V-NXS/MD100-15/L	4"
V-NXS/MD100-15/R	4"
V-NXS/MD150-15/L	6"
V-NXS/MD150-15/R	6"
V-NXS/MD200-15/L	8"
V-NXS/MD200-15/R	8"

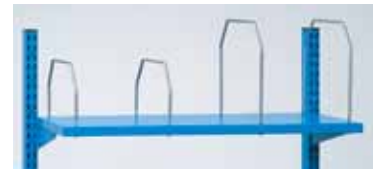

Vertical Wire Dividers for Adjustable Shelves Without Lip

MODEL NO.	HEIGHT
FOR 12" DEEP SHELVES	
V-NXS/WD150-12	6"
V-NXS/WD250-12	10"
V-NXS/WD450-12	18"
FOR 15" DEEP SHELVES	
V-NXS/WD150-15	6"
V-NXS/WD250-15	10"
V-NXS/WD450-15	18"

SHELVES

Variable Angle Shelves

- Shelf adjusts from totally flat to a 25° angle and has a capacity of 150 lbs. for evenly distributed loads
- Can be mounted in a forward or set-back position between uprights for maximum flexibility



Variable Angle Shelves Without Lip

- Shelves are 18" or 24" deep with a 150 lb. weight capacity
- Can be mounted in a forward or set-back position between uprights for maximum flexibility
- Prepunched holes accept vertical wire dividers (see below)



Vertical Wire Dividers for Deep Shelves Without Lip

- Dividers are 1/4" diameter galvanized wire that fit into prepunched holes in the shelf
- No hardware required
- Depth must match shelf depth



Variable Angle Shelves

MODEL NO.	SHELF WID.	SEC. WIDTH
18" DEEP		
V-NXS/V2418L	22 1/2"	24"
V-NXS/V3018L	28 1/2"	30"
V-NXS/V3618L	34 1/2"	36"
V-NXS/V4218L	40 1/2"	42"
V-NXS/V4818L	46 1/2"	48"
V-NXS/V6018L	58 1/2"	60"
24" DEEP		
V-NXS/V2424L	22 1/2"	24"
V-NXS/V3024L	28 1/2"	30"
V-NXS/V3624L	34 1/2"	36"
V-NXS/V4224L	40 1/2"	42"
V-NXS/V4824L	46 1/2"	48"

Variable Angle Shelves Without Lip

MODEL NO.	SHELF WIDTH
18" DEEP	
V-NXS/V2418D	24"
V-NXS/V3018D	30"
V-NXS/V3618D	36"
V-NXS/V4218D	42"
V-NXS/V4818D	48"
V-NXS/V6018D	60"
24" DEEP	
V-NXS/V2424D	24"
V-NXS/V3024D	30"
V-NXS/V3624D	36"
V-NXS/V4224D	42"
V-NXS/V4824D	48"

Vertical Wire Dividers for Deep Shelves Without Lip

MODEL NO.	HEIGHT
FOR 18" DEEP SHELVES	
V-NXS/WD150-18	6"
V-NXS/WD250-18	10"
V-NXS/WD450-18	18"
FOR 24" DEEP SHELVES	
V-NXS/WD150-24	6"
V-NXS/WD250-24	10"
V-NXS/WD450-24	18"

LIGHTING ACCESSORIES

Overhead Light Fixtures

- Fluorescent fixture is available in 2-bulb or 4-bulb model in 44" or 56" length
- Tilts up or down 10°
- Brackets allow light fixture to be mounted to frame sections 30" to 90" wide
- Kit includes switch and 8' grounded electrical cord, support track, standard acrylic diffuser and T8 bulbs. Requires V-NX/OHL-TR/BRK support brackets (See right).
- Fixture available in Light Gray only, but brackets can be ordered in any color
- Bracket with fixture can also simultaneously support tool rail



Overhead Light Fixture Kits

MODEL NO. 2-BULB	FIXTURE WIDTH	SECTION WIDTH
V-NX/OHL-R48/2	44"	30"-48"
V-NX/OHL-R60/2	56"	49"-60"
V-NX/OHL-R72/2	56"	61"-72"
V-NX/OHL-R78/2	56"	73"-78"
V-NX/OHL-R84/2	56"	79"-84"
V-NX/OHL-R90/2	56"	85"-90"

4-BULB	FIXTURE WIDTH	SECTION WIDTH
V-NX/OHL-R48/4	44"	30"-48"
V-NX/OHL-R60/4	56"	49"-60"
V-NX/OHL-R72/4	56"	61"-72"
V-NX/OHL-R78/4	56"	73"-78"
V-NX/OHL-R84/4	56"	79"-84"
V-NX/OHL-R90/4	56"	85"-90"

Overhead Light Fixtures Only

MODEL NO.	BULBS	WIDTH
V-NX/OHL44/2	2	44"
V-NX/OHL44/4	4	44"
V-NX/OHL56/2	2	56"
V-NX/OHL56/4	4	56"



Overhead Light and Tool Rail Support Brackets

MODEL NO.	BRACKET DEPTH
V-NX/OHL-TR/BRK24	24"
V-NX/OHL-TR/BRK30	30"

Parabolic Diffusers for Light Fixture

MODEL NO.	USE WITH
V-NX/OHL-PD44	44" light fixture
V-NX/OHL-PD56	56" light fixture



Undershelf Task Lights

MODEL NO.	SIZE	BULB
V-FLF-18	18" W x 5" D x 1 3/4" H	HF15T8



TOOL RAILS AND POWER OPTIONS

Tool Rails

- The tool rail spans the length of the worksurface
- Available in 48", 60" or 72" lengths
- Each tool rail has a 30 lb. capacity, and comes complete with a trolley, 2 hangers, 2 endstops, and 2 end caps in black finish
- Balancer not included. Requires support brackets
- Fixture and bracket can also simultaneously support overhead light
- Color is Black



Tool Rails

MODEL NO.	LENGTH
V-TR48	48"
V-TR60	60"
V-TR72	72"

Swing Arm Tool Rail

- The swing arm tool rail is 36" in length and swings 180°
- It has a 30 lb. capacity and includes a trolley, 1 endstop, and 1 end cap
- Includes mounting bracket
- Balancer not included
- Color is Black



Swing Arm Tool Rail

MODEL NO.	LENGTH
V-SWT36	36"

Single Uprights

- Economical solution to mounting power or articulating component above the worksurface
- Capacity 60 lbs.

Single Uprights

MODEL NO.	HEIGHT
V-NXF-P30/SM	30"
V-NXF-P48/SM	48"

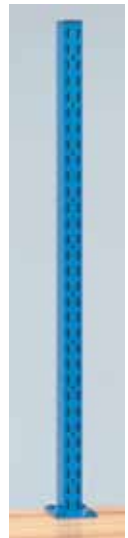

Airhose Attachment

- Small bracket attaches to frame upright
- Quick-connect fitting not supplied



Airhose Attachment

MODEL NO.	DESCRIPTION
V-NX/AHB	Bracket for air supply

Vertical Power Strips

- Mounts vertically to front and back of upright
- Bracket and hardware supplied
- Lighted on/off switch, 6' cord with grounded plug and circuit breaker are included
- Fixture and brackets are Black



Vertical Power Strips

MODEL NO.	DESCRIPTION
V-NXVPS/15	15 amp with 6 outlets
V-NXVPS/20	20 amp with 6 outlets
V-NXVPS/15GF	15 amp GFCI w/6 outlets
V-NXVPS/20GF	20 amp GFCI w/6 outlets



Horizontal Power Rails

MODEL NO. 15 AMP	MODEL NO. 20 AMP
V-NXHPS/24-15	V-NXHPS/24-20
V-NXHPS/30-15	V-NXHPS/30-20
V-NXHPS/36-15	V-NXHPS/36-20
V-NXHPS/42-15	V-NXHPS/42-20
V-NXHPS/48-15	V-NXHPS/48-20
V-NXHPS/60-15	V-NXHPS/60-20

15 AMP GFCI	20 AMP GFCI
V-NXHPS/24-15GF	V-NXHPS/24-20GF
V-NXHPS/30-15GF	V-NXHPS/30-20GF
V-NXHPS/36-15GF	V-NXHPS/36-20GF
V-NXHPS/42-15GF	V-NXHPS/42-20GF
V-NXHPS/48-15GF	V-NXHPS/48-20GF
V-NXHPS/60-15GF	V-NXHPS/60-20GF

PLASTIC BOX RAILS, BACK STOPS AND ROLL HOLDERS

Plastic Box Rails

- The plastic box rail is easily adjustable for ergonomic access
- It can be mounted parallel to the worksurface or at a 15° angle
- The rail is attached via a simple double-notch system
- It can hold boxes that have hanger lips at the rear for attaching to a louvered panel
- Plastic boxes not included
- Must match the width of your chosen section frame
- Specify color from chart on page 164



Plastic Box Rails

MODEL NO.	WIDTH	MAXIMUM # OF 3" BOXES/RAIL
V-NXBR/24	24"	7
V-NXBR/30	30"	9
V-NXBR/36	36"	11
V-NXBR/42	42"	13
V-NXBR/48	48"	15
V-NXBR/60	60"	19

Back Stops

- Prevents items from rolling off worksurface, 3" in height
- Painted to match frame. Must match the width of your chosen section frame
- Specify color from chart on page 164



Back Stops

MODEL NO.	USE WITH SECTION WIDTH
V-NXBS/24	24"
V-NXBS/30	30"
V-NXBS/36	36"
V-NXBS/42	42"
V-NXBS/48	48"
V-NXBS/60	60"

Roll Holders (Extended Mount)

- For dispensing paper, bubble rolls, etc. Includes 1" diameter rod and brackets
- Brackets mount to uprights and extend 3" forward from the face of the uprights to allow for larger diameter rolls
- Rod is unpainted galvanized steel; brackets are painted to match frame
- 100 lb. weight capacity



Roll Holders (Extended Mount)

MODEL NO.	USE WITH SEC. WIDTH	USB. INSIDE WIDTH
V-NXRH/E24	24"	22"
V-NXRH/E30	30"	28"
V-NXRH/E36	36"	34"
V-NXRH/E42	42"	40"
V-NXRH/E48	48"	46"
V-NXRH/E60	60"	58"

Label/Roll Holders (Interior Mount)

- For dispensing labels and other smaller rolls
- Brackets mount flush between uprights. Includes 1" diameter rod and brackets
- Rod is unpainted galvanized steel; brackets are painted to match frame
- 100 lb. weight capacity



Label/Roll Holders (Interior Mount)

MODEL NO.	USE WITH SEC. WIDTH	USB. INSIDE WIDTH
V-NXRH/C24	24"	22"
V-NXRH/C30	30"	28"
V-NXRH/C36	36"	34"
V-NXRH/C42	42"	40"
V-NXRH/C48	48"	46"
V-NXRH/C60	60"	58"

OVERHEAD CABINETS

- Overhead cabinets can attach to a system frame for protected, secure above-worksurface storage of large, bulky items
- Available without doors, or with a choice of door options
- Note: Mounting brackets must be ordered separately (See add-on accessories below)



Overhead cabinet with recessed door

MODEL NO.	DESCRIPTION	DIMENSIONS W X D X H
ATOS24190005	24" Overhead / Housing Only	24" x 15" x 19"
ATOS30190005	30" Overhead / Housing Only	30" x 15" x 19"
ATOS36190005	36" Overhead / Housing Only	36" x 15" x 19"
ATOS48190005	48" Overhead / Housing Only	48" x 15" x 19"
ATOS24190005R	24" Overhead Cabinet / Recessed Doors	24" x 15" x 19"
ATOS30190005R	30" Overhead Cabinet / Recessed Doors	30" x 15" x 19"
ATOS36190005R	36" Overhead Cabinet / Recessed Doors	36" x 15" x 19"
ATOS48190005R	48" Overhead Cabinet / Recessed Doors	48" x 15" x 19"



Overhead cabinet with gas strut door

MODEL NO.	DESCRIPTION	DIMENSIONS W X D X H
ATOS24190005G	24" Overhead Cabinet / Gas Strut Doors	24" x 15" x 19"
ATOS30190005G	30" Overhead Cabinet / Gas Strut Doors	30" x 15" x 19"
ATOS36190005G	36" Overhead Cabinet / Gas Strut Doors	36" x 15" x 19"
ATOS48190005G	48" Overhead Cabinet / Gas Strut Doors	48" x 15" x 19"

ADD-ON ACCESSORIES:

MODEL NO.	DESCRIPTION	DIMENSIONS W X D X H
ATOS2BP24	24" Overhead Cabinet Back Cover Panel	24" L x 19" H
ATOSBP30	30" Overhead Cabinet Back Cover Panel	30" L x 19" H
ATOSBP36	36" Overhead Cabinet Back Cover Panel	36" L x 19" H
ATOSBP48	48" Overhead Cabinet Back Cover Panel	48" L x 19" H
ATSLT24	24" Sloped Top	24" x 15" x 7 1/4"
ATSLT30	30" Sloped Top	30" x 15" x 7 1/4"
ATSLT36	36" Sloped Top	36" x 15" x 7 1/4"
ATSLT48	48" Sloped Top	48" x 15" x 7 1/4"
CYLSEC5	Overhead Lock For Housings With Doors	—
V-NX/OHC-BRK16*	Cabinet Rear Mounting Bracket (Pair)	—

*Note: must have bracket to mount overhead cabinets to Nexus frame

PANELS AND MARKERBOARD/TACKBOARDS

Louvered Panels

- Steel louvered panel is designed to accommodate industry-standard plastic boxes that feature louvered edge or lip

Pegboard Panels

- Steel pegboard panel accepts all standard pegging devices (i.e. hooks, etc.)
- Pegboard holes are 1/4" in diameter
- Ideal for placement of commonly used tools

Solid Privacy Panels

- Steel privacy panel encloses a section and can also be used to hold/display items with magnets

Reversible Markerboard/Tackboards

- Two-sided reversible board
- Features white magnetic markerboard on one side and gray fabric tackboard on the other
- Also functions as privacy panel and sound dampener
- 30" high

Louvered Panels

MODEL NO.	USE WITH SECTION WIDTH
18" HIGH	
V-NXLP/2418	24"
V-NXLP/3018	30"
V-NXLP/3618	36"
V-NXLP/4218	42"
V-NXLP/4818	48"
V-NXLP/6018	60"
30" HIGH	
V-NXLP/2430	24"
V-NXLP/3030	30"
V-NXLP/3630	36"
V-NXLP/4230	42"
V-NXLP/4830	48"
V-NXLP/6030	60"

Solid Privacy Panels

MODEL NO.	USE WITH SECTION WIDTH
18" HIGH	
V-NXSP/2418	24"
V-NXSP/3018	30"
V-NXSP/3618	36"
V-NXSP/4218	42"
V-NXSP/4818	48"
V-NXSP/6018	60"
30" HIGH	
V-NXSP/2430	24"
V-NXSP/3030	30"
V-NXSP/3630	36"
V-NXSP/4230	42"
V-NXSP/4830	48"
V-NXSP/6030	60"

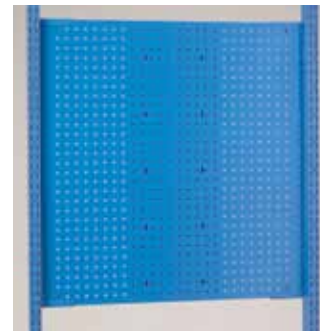

Pegboard Panels

MODEL NO.	USE WITH SECTION WIDTH
18" HIGH	
V-NXPP/2418	24"
V-NXPP/3018	30"
V-NXPP/3618	36"
V-NXPP/4218	42"
V-NXPP/4818	48"
V-NXPP/6018	60"
30" HIGH	
V-NXPP/2430	24"
V-NXPP/3030	30"
V-NXPP/3630	36"
V-NXPP/4230	42"
V-NXPP/4830	48"
V-NXPP/6030	60"



Reversible Markerboard/Tackboards

MODEL NO.	USE WITH SEC. WIDTH
V-NXRMT/2430	24"
V-NXRMT/3030	30"
V-NXRMT/3630	36"
V-NXRMT/4230	42"
V-NXRMT/4830	48"

PIVOTING ACCESSORIES

Document Holder

- For displaying papers, plans, etc.
- 11 7/8" wide x 13 3/4" high
- Includes lip for pencils, pens, etc.



Large Document Holder

- For displaying large documents, and open binders and books
- 23 5/8" wide x 13 3/4" high
- Includes lip for pencils, pens, etc.



Bin Container

- Holds 3 rows of plastic bins for easy access to parts and components
- Interior space per shelf is 20" wide x 6" deep
- Top shelf is 3 1/4" high, second and third shelves are 3 3/4" high
- Requires accessory shelf for support (not included), or can be freestanding
- Does not include bin boxes
- 50 lb. capacity



Equipment Shelf

- Holds a variety of customer-supplied equipment or tools
- 12 3/8" wide x 12 3/8" deep
- 75 lb. capacity



Document Holder

MODEL NO.	DESCRIPTION
V-NXA/DH	Document Holder

Large Document Holder

MODEL NO.	DESCRIPTION
V-NXA/DHW	Large Document Holder

Bin Container

MODEL NO.	DESCRIPTION
V-NX/AS-BC	Bin Container

Equipment Shelf

MODEL NO.	DESCRIPTION
V-NX/A/ES	Equipment Shelf

PIVOTING ACCESSORIES

Accessory Shelf

- For easy access to small tools, instruments, parts, etc
- Ribbed rubber mat optional
- 21 1/4" wide x 7 3/8" deep
- 75 lb. capacity



Accessory Shelf

MODEL NO.	DESCRIPTION
V-NXA/AS	shelf
V-NX/AS-MAT	ribbed rubber mat

Flat Panel Monitor Arm

- For attaching flat panel monitor to upright
- Accepts both 75mm and 100mm square monitor hole patterns
- Includes bracket
- 17 1/2 lb. capacity



Flat Panel Monitor Arm

MODEL NO.	DESCRIPTION
V-NXA/FPMA	Flat Panel Monitor Arm

Flat Panel Monitor Arm

- Articulates horizontally
- Factory pretensioned articulated head and joints
- Mounts to column
- Maximum reach 16"
- Supports up to 18 lbs.



Flat Panel Monitor Arm

MODEL NO.	DESCRIPTION
V-4037	Flat Panel Monitor Arm

PIVOTING ACCESSORIES

Dual Flat Panel Monitor Arm

- Articulates horizontally
- Factory pretensioned articulated head and joints
- Mounts to column
- Maximum reach 16"
- Supports up to 18 lbs. per arm



Full Function Flat Panel Monitor Arm

- Six lockable positions for arm and Vesa plate
- Articulates horizontally and vertical
- Factory pretensioned articulated head
- Mounts to column
- 12" height adjustment
- Maximum reach 15 7/8"
- Supports up to 26 lbs.



New Gas Assist Tablet Monitor Arm

- Gas assist for easy, fluid movement
- Articulates horizontally and vertically
- Factory pre-tensioned articulating head
- Mounts to Arlink® 8000 and Nexus uprights
- Secure tablet holder
- Maximum reach 16.7" (424mm)
- Supports up to 5 lbs. (2.3kg)

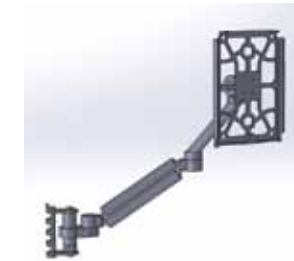

Dual Flat Panel Monitor Arm

MODEL NO.	DESCRIPTION
V-4045	Dual Flat Panel Monitor Arm

Full Function Flat Panel Monitor Arm

MODEL NO.	DESCRIPTION
V-4036	Full Function Flat Panel Monitor Arm

New Gas Assist Tablet Monitor Arm

MODEL NO.	DESCRIPTION
4047	Gas Assist tablet arm: Secured iPad 2, 3 & 4 Holder; Column Mount (Weight 6 lbs.)
4057	Gas Assist tablet arm: Secured iPad Air Holder; Column Mount (Weight 6 lbs.)

FLAT PANEL MONITOR ARMS

Vidmar is introducing a new, expanded offering of flat panel monitor arms, selected for its high quality and functionality. The goal of this expanded offering is to have a functional, affordable product in two competitive price points.

Features

- Made from 70% recycled material (green credits)
- Milled from 60-61 T6 aircraft grade, billet aluminum
- Arm finish: anodized
- Column bracket finish: available in Light Gray and Sand
- Manufactured in North America
- New bracket takes up less vertical column space (5")
- More mounting options
- Limited lifetime warranty
- FOB: Factory

The new arms will be available in three styles:

- Basic arm with left to right articulation—post and column mount available
- Full function arm with left to right and vertical articulation—post and column mount available
- Cross beam for multiple monitors

Monitor Mounting Rails and Mounting Knuckles

- Allows multiple monitors on multiple levels
- Clamp mount knuckle can be positioned to any horizontal position
- 5" knuckles allow tilt and angle adjustment
- Vesa 75/100 interface plate
- Rail locks into Arlink 8000 and Nexus micro slots
- Each rail includes 1 monitor mounting knuckle
- Specify additional knuckles as required
- Monitor size will dictate number of monitors that can be accommodated per rail
- Some assembly required
- Mounts to Arlink 8000 and Nexus uprights

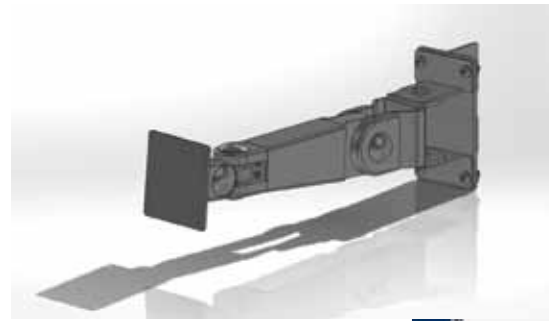

Flat Panel Monitor Arms

PART NO.	DESCRIPTION
8415	attaches to column
8628	includes 9" bracket extender

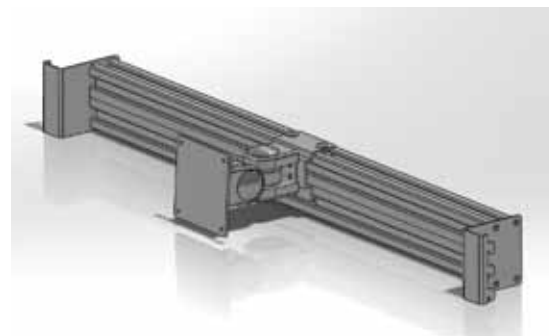

Monitor Mounting Rails

PART NO.	DESCRIPTION	WEIGHT
4070	30" Rail with 1 Knuckle	12 lbs.
4071	36" Rail with 1 Knuckle	13 lbs.
4072	48" Rail with 1 Knuckle	15 lbs.
4073	60" Rail with 1 Knuckle	17 lbs.
4074	72" Rail with 1 Knuckle	19 lbs.
4075	Monitor Knuckle for Rail	2 lbs.

BASIC FLAT PANEL MONITOR ARMS

Basic monitor arm is either column mount or post mount, with left to right articulation. Has a 16" reach, with single or double arm options.

4037 – Basic Flat Panel Monitor Arm: Horizontal Articulation; Column Mount

- Articulates horizontally
- Factory pretensioned articulated head
- Factory pretensioned joints
- Vesa 75/100 interface plate
- Supports up to 18 lbs. (8kg)
- Maximum reach 16" (407mm)
- Mounts to Arlink 8000 and Nexus uprights

4045 – Basic Dual Flat Panel Monitor Arm: Horizontal Articulation; Column Mount

- Articulates horizontally
- Factory pretensioned articulated head
- Factory pretensioned joints
- Vesa 75/100 interface plate
- Supports up to 18 lbs. (8kg) per arm
- Maximum reach 16" (407mm)
- Mounts to Arlink 8000 and Nexus uprights

4054 – Basic Flat Panel Monitor Arm: Horizontal Articulation; Post Mount

- Articulates horizontally
- Factory pretensioned articulated head
- Factory pretensioned joints
- Vesa 75/100 interface plate
- Supports up to 18 lbs. (8kg)
- Maximum reach 16" (407mm)
- Solid 1" diameter 13" high aluminum post
- Mounts through worksurface, hole diameter 12"



Basic Flat Panel Monitor Arm

PART NO.	DESCRIPTION	WEIGHT
4037	Basic Flat Panel Monitor Arm, Column Mount	6 lbs.



Basic Dual Flat Panel Monitor Arm

PART NO.	DESCRIPTION	WEIGHT
4045	Basic Dual Flat Panel Monitor Arm, Column Mount	12 lbs.



Basic Flat Panel Monitor Arm

PART NO.	DESCRIPTION	WEIGHT
4054	Basic Flat Panel Monitor Arm, Post Mount	6 lbs.

4060 – Basic Dual Flat Panel Monitor Arm: Horizontal Articulation; Post Mount

- Articulates horizontally
- Factory pretensioned articulated head
- Factory pretensioned joints
- Vesa 75/100 interface plate
- Supports up to 18 lbs. (8kg) per arm
- Maximum reach 16" (407mm)
- Solid 1" diameter 13" high aluminum post
- Mounts through worksurface, hole diameter 1/2"



PART NO.	DESCRIPTION	WEIGHT
4060	Basic Dual Flat Panel Monitor Arm, Post Mount	18 lbs.

NEW FULL FUNCTION FLAT PANEL MONITOR ARMS

Full function monitor arm is either column mount or post mount, with left to right articulation and vertical angle adjustment. Has a 16" reach (optional 26"), with single or double arm options.

4036 – Full Function Flat Panel Monitor Arm: Vertical and Horizontal Articulation; Column Mount

- 6 lockable positions for arm and Vesa plate
- Articulates horizontally and vertically
- Factory pretensioned articulated head
- Vesa 75/100 interface plate
- Supports up to 26 lbs. (12kg)
- 12" height adjustment
- Maximum reach of 15.9" (404mm)
- Mounts to Arlink® 8000 and Nexus uprights



PART NO.	DESCRIPTION	WEIGHT
4036	Full Function Flat Panel Monitor Arm, Column Mount	8 lbs.

4044 – Full Function Dual Flat Panel Monitor Arm: Vertical and Horizontal Articulation; Column Mount

- 6 lockable positions for arm and Vesa plate
- Articulates horizontally and vertically
- Factory pretensioned articulated head
- Vesa 75/100 interface plate
- Supports up to 26 lbs. (12kg) per arm
- 12" height adjustment
- Maximum reach of 15.9" (404mm)
- Mounts to Arlink® 8000 and Nexus uprights



PART NO.	DESCRIPTION	WEIGHT
4044	Full Function Dual Flat Panel Monitor Arm, Column Mount	16 lbs.

4053 – Full Function Flat Panel Monitor Arm: Vertical and Horizontal Articulation; Post Mount

- 6 lockable positions for arm and Vesa plate
- Articulates horizontally and vertically
- Factory pretensioned articulated head
- Vesa 75/100 interface plate
- Supports up to 26 lbs. (12kg)
- 12" height adjustment
- Maximum reach of 15.9" (404mm)
- Solid 1.5" diameter 15.75" high aluminum post
- Mounts through worksurface, hole diameter 1/2"



PART NO.	DESCRIPTION	WEIGHT
4053	Full Function Flat Panel Monitor Arm, Post Mount	8 lbs.

4059 – Full Function Dual Flat Panel Monitor Arm: Vertical and Horizontal Articulation; Post Mount

- 6 lockable positions for arm and Vesa plate
- Articulates horizontally and vertically
- Factory pretensioned articulated head
- Vesa 75/100 interface plate
- Supports up to 26 lbs. (12kg) per arm
- 12" height adjustment
- Maximum reach of 15.9" (404mm)
- Solid 1.5" diameter 15.75" high aluminum post
- Mounts through worksurface, hole diameter 1/2"

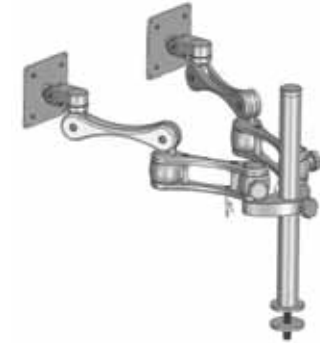

PART NO.	DESCRIPTION	WEIGHT
4059	Full Function Dual Flat Panel Monitor Arm, Post Mount	16 lbs.

FLAT PANEL MONITOR ARM ADDITIONAL OPTIONS

4063 – Full Function Extended Flat Panel Monitor Arm: Vertical and Horizontal Articulation; Column Mount, with 9 1/4" Extension

- 6 lockable positions for arm and Vesa plate
- Articulates horizontally and vertically
- Factory pretensioned articulated head
- Vesa 75/100 interface plate
- Supports up to 22 lbs. (10kg)
- 12" height adjustment
- Maximum reach of 25" (635mm)
- Mounts to Arlink® 8000 and Nexus uprights



PART NO.	DESCRIPTION	WEIGHT
4063	Full Function Extended Flat Panel Monitor Arm, Col. Mount	10 lbs.

SEATING

- Seating by Vidmar, the ultimate combination of down-and-dirty ruggedness and hour-after-hour comfort
- Built Vidmar-tough for performance that lasts and ergonomically designed to ensure proper body support
- Seating is available in an array of styles for specific job tasks

DELUXE INDUSTRIAL CHAIR

The most rugged, versatile seat in the line.

VCHRDIXND

Seat: 18.5" W x 18.5" D x 2" T
Back: 16.5" W x 15.5" H x 2" T
Base: 1.25" x 26" Dia., 11" H



Seating available with or without casters and arm rests.
Seating available in Black only.

PRODUCTION CHAIR

The ideal chair for repetitive work tasks.

VCHRPRODN

Seat: 18.5" W x 18.5" D x 2" T
Back: 16.5" W x 15.5" H x 2" T
Base: 25" Dia., 6" H



Production Chair

DELUXE ESD CHAIR

Vidmar toughness in a Electro-Static Dissipative (ESD)-protective work chair.

VCHRDIXESD

Seat: 18.5" W x 18.5" D x 2" T
Back: 16.5" W x 15.5" H x 2" T
Base: 25" Dia., 6" H



ESD casters available

Deluxe ESD Chair

MULTI-TASK CHAIR

Designed for heavy-duty industrial settings and multi-height work surfaces.

VCHRMTSK

Seat: 18.5" W x 18.5" D x 2" T
Back: 16.5" W x 15.5" H x 2" T
Base: 26" Dia., 5" H



Multi-Task Chair

SIT-STAND STOOL

Create the ultimate work environment for standing workers.

VSTLSITSTAND

Seat: 12" x 8" Oval
Base: 20" W x 16" D



Sit-Stand Stool

TOOL TROLLEY

Maximum comfort and convenience when working in a low position.

VSTLTROLLEY

Seat: 13" Dia.
Base: 20" Dia., 5.5" H



Tool Trolley



Glides optional



Multi-Purpose Stool

MULTI-PURPOSE STOOL

The one stool you need for a long list of jobs.

VSTLMPURP

Seat: 13" Dia.
Base: 24" Dia., 6" H



VIDMAR® ADJUSTABLE RACKING SYSTEM



Flexible. Heavy-Duty. Efficient.

The Adjustable Racking System is based on moveable pallets (instead of fixed shelves) that maximize every inch of your vertical storage space. Pallets can be continually adjusted or expanded to meet your changing storage needs.

- For use with existing forklift
- Removable, fully adjustable pallets that can change and grow with you
- Racking is available up to 16' high for maximum vertical storage space
- Systems can be broken up to fit around unavoidable building structures
- Array of convenient storage accessories



Adjustable Racking is a stand-alone storage system

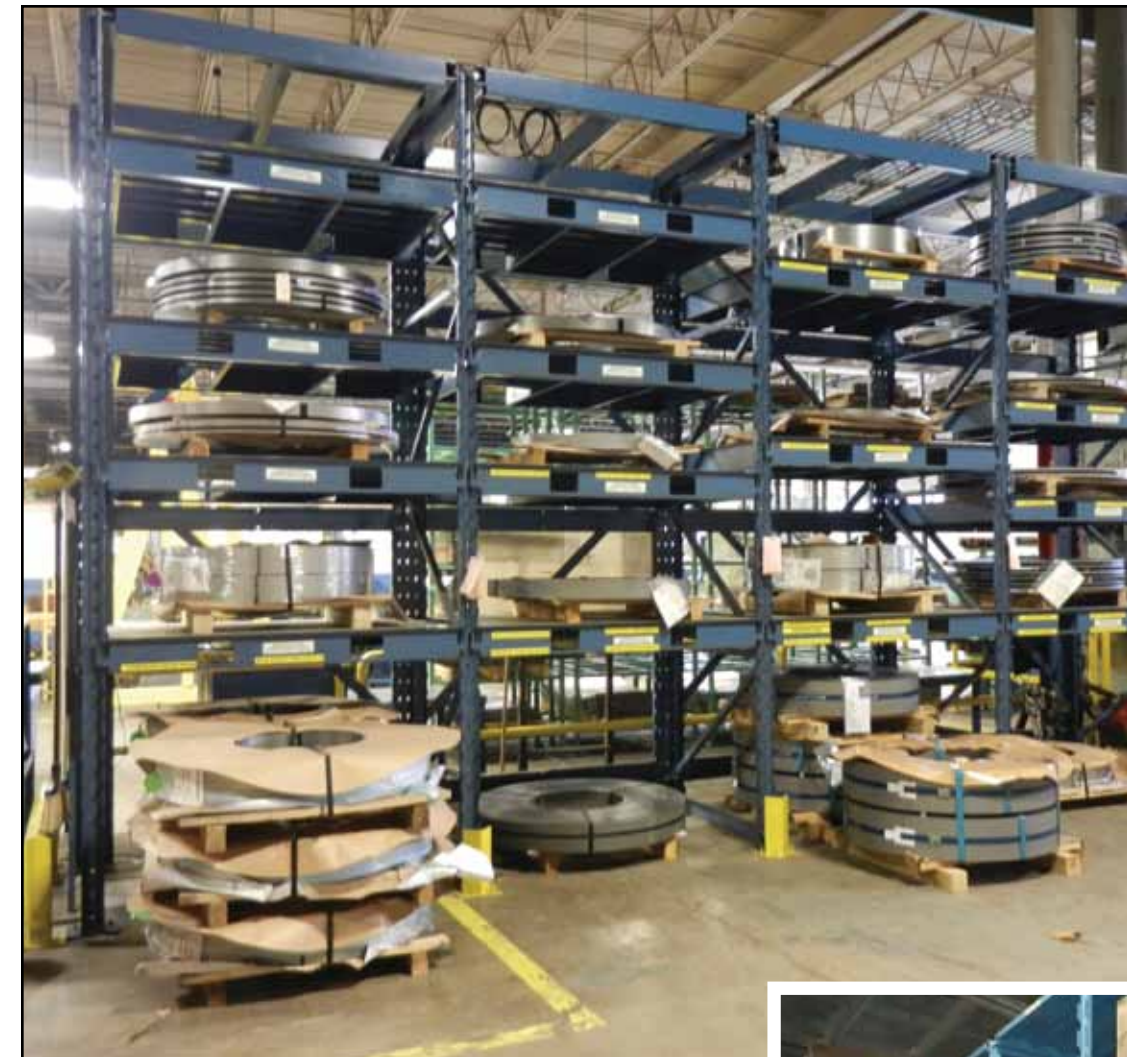

Available up to 16' high



Adjustable pallet positions

VIDMAR® STAK SYSTEM®

Easy storage. Even easier retrieval.

Storage and retrieval of heavy, bulky items has never been easier. Our STAK Systems® offer the ultimate in flexibility for storage, load capacity, space-savings, and money-savings.

Choose from:

- Access pallets with captive lifting device
- STAK System®—Removable, adjustable pallets and a captive lifting and handling device that facilitates retrieval in as little as two minutes. One operator can manage loads up to 2,000 lbs. in less than 250 square feet
- 4K STAK—All the features and benefits of STAK, plus the capability to build up to 18' 4" high and pallet loads up to 4,000 lbs. Choose from six additional pallet widths (19 sizes total)
- HazMat STAK System®—Designed specifically for the storage, staging, and retrieval of 55-gallon hazardous material drums, Factory Mutual Approval HazMat STAK System gets your drums off the floor and into their own dedicated storage system without having to use a conventional forklift



Designed for safety and ergonomic operation



One operator can manage loads up to 2,000 lbs.



Vidmar® STAK System®



DYNAMIC PALLET-BASED STORAGE AND HANDLING SYSTEM



Store or retrieve loads more quickly—regardless of size, shape, or weight!

- Space Savings—Squeeze wasted air out of your vertical storage and make use of every cubic foot! Free up floor space for other uses
- Value—Maximize the use of your cubic space, and get more productivity from your entire facility
- Manpower Efficiency—Retrieve items weighing up to 2 tons with just one person
- Ergonomic Safety—Lifting and handling device is engineered for maximum ease of use
- Ease of Retrieval and Inventory Control—Stored items are easily located, positioned and repositioned
- Precise Load Positioning—Pallets are positioned in the STAK System® at vertical increments of 4", so items can be stored exactly where you want them, on the fly
- Reduced Use of Fork Trucks—Fewer fork trucks means greater savings, greater safety on your shop floor and less wear and tear to floor
- Operation of the STAK System lifting and handling device doesn't require certification
- Product Protection and Security—Store large items on safe, protected pallets, off the floor.
- Ideal for work-in-process, maintenance, tooling and fixturing, and supply and distribution
- Available as 2K STAK System (2,000-lb. capacity), 4K STAK System (4,000-lb. capacity), or HazMat STAK System (2,000-lb. capacity). Consult factory for capacities above 4,000 lbs., extended height systems, or oversized pallets
- The STAK System is designed to be easily expanded incrementally as your storage needs grow
- With a long list of available accessories, your STAK System can be designed to your facility's exact requirements



Store a wide range of items of varying sizes, shapes and heights, with a minimum of wasted space!



Aisle space requirements are narrower than those required when using a conventional forklift.



The system can be configured in a number of ways, and can incorporate mid-aisle access.



The STAK System® is available in a variety of configurations to suit your specific needs.

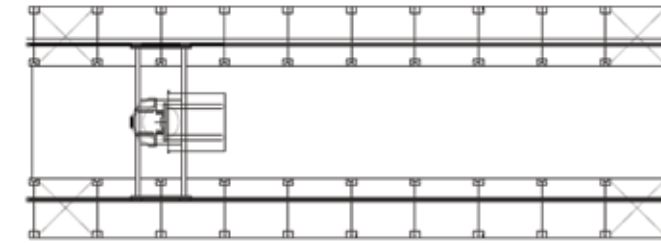

Double-sided standard

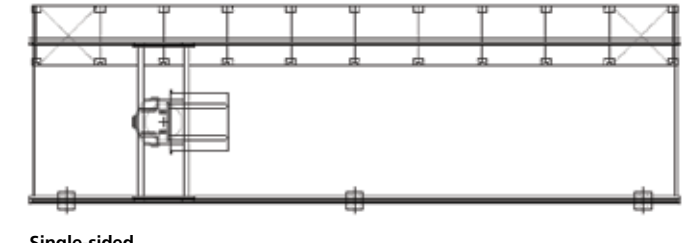

Single-sided

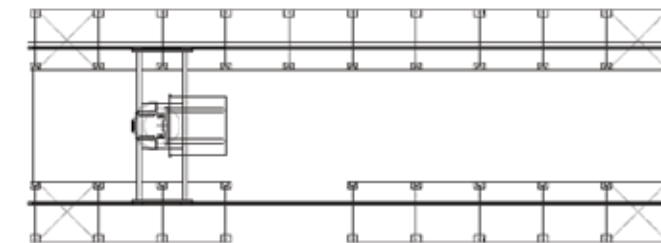

Double-sided with single mid-aisle access

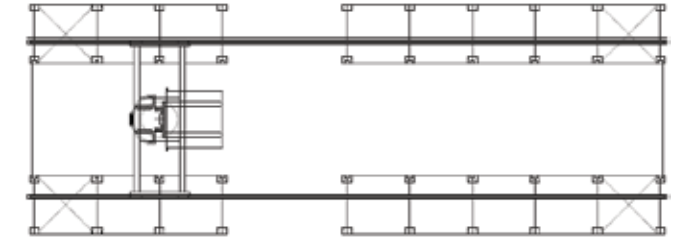

Double-sided with pair of mid-aisle access

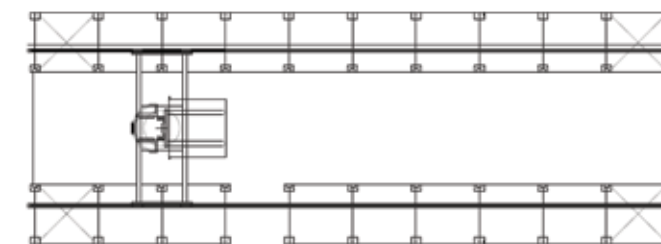

Double-sided with walk-through only access

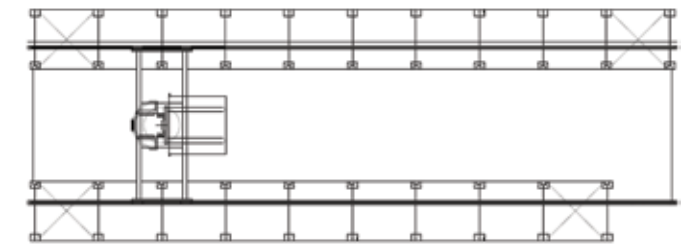

Double-sided with half cantilever

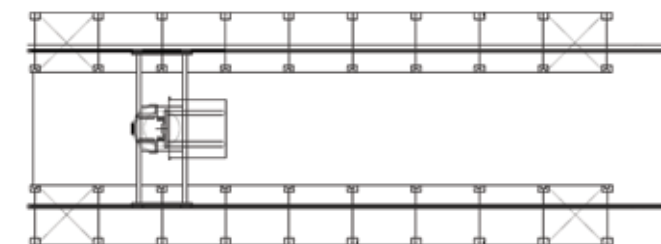

Double-sided with full cantilever

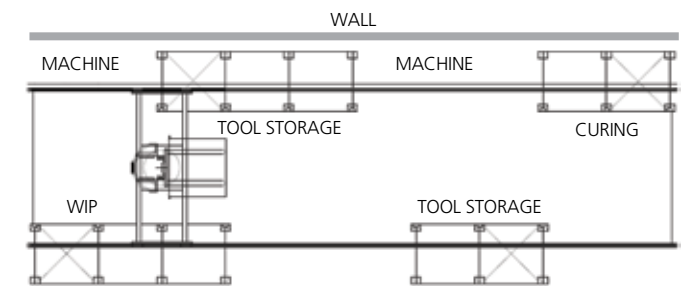

Flexible solutions to meet unique needs. Above layout is just an example of the configurations we can design to solve your tough problems.

VIDMAR® TOWER™ AND VIDMAR® TOWER XL™



A variety of Tower™ and Tower XL™ configurations offer your choice of performance and capacity for your particular storage needs. Tower-series storage solutions cover a range of module capacities, drawer capacities, vertical and horizontal speeds, and picking bay styles.

- Save more than 75% of your floor space
- Improve efficiency with faster part and tool retrieval
- Reduce labor with increased throughput rates
- Increase picking accuracy
- Minimize reaching, bending, and searching
- Improve inventory control
- Increase your bottom line



External picking bay



Internal picking bay



Unlimited drawer configurations



High-Density Storage:

The Vertical Lift Module is designed to take advantage of every inch of available space! Configure your drawers to maximize your storage capacity.

Closing Doors:

Sliding doors can be installed if doors need to be closed to avoid unauthorized access. Automatic closing doors are standard on internal bay machines, optional on external bay machines.

Fast Picking:

Maximize operator efficiency.

Safety:

Local lock-out and tag-out disconnects available, along with an emergency stop. All motors have brake locks, and all units have product height and personnel protection sensors.

Security:

Locking doors are optional; automatic doors are standard on internal bay machines, optional on others. User access is via password/barcode.

Flexible Bay Options:

Picking bays can be internal or external, front and back of machine, or stacked above one another.

Sliding Electronic Box:

Allows quick diagnosis and fast, safe maintenance.

Modular Construction:

The Vertical Lift Module can be built up to 40' high, with your choice of drawers, drawer height and depth, drawer configuration, and picking bay positioning.

Barcode Reader:

Bar code reader is designed to help pick stored items faster and more accurately. Wireless reader also available.

Ergonomic Bay Design:

Picking bays are designed to allow optimal picking times and help limit overreach.

Unlimited Drawer Configurations:

Drawers are available open or with adjustable partitions and dividers that can be custom-configured to suit your storage needs. Drawer height is adjustable.

Partitions & Dividers:

Plain or slotted partitions and dividers are available for the custom structuring of compartments (totes are also available). Raised drawer sides help contain bulky items.

Steel Core Belt

Vertical Transmission: Quicker, more reliable, and less noisy than traditional chain transmission.

Computer-Based Operation:

Touch screen console allows easy access to all operational functions at any time. Drawers can be accessed by drawer number, part number, or part description.

Flexible Management Software:

Windows XP®-based management software is available in three basic configurations that offer thousands of operating possibilities.

Sliding Touch Screen Console:

Allows operator to work close to console at any picking point. Available with external bay only.

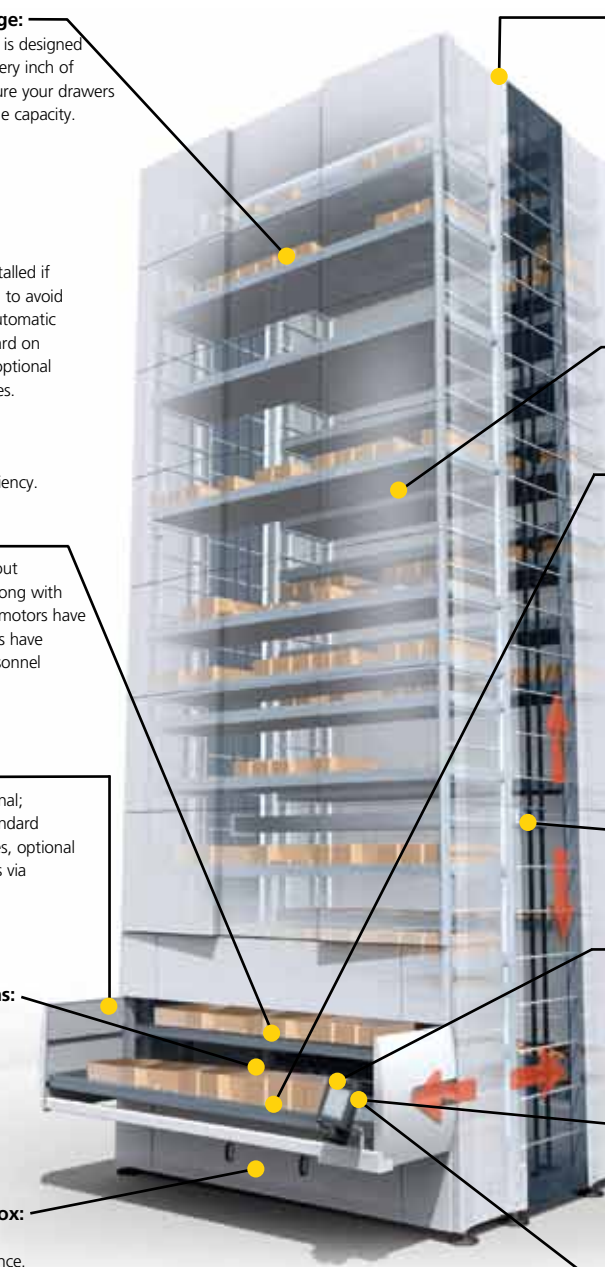

VIDMAR® MOTORIZED CAROUSEL

A Vidmar® Motorized Carousel maximizes vertical space, provides quick, easy access to hard-to-reach inventory, and offers complete load containment.

- One-Person Operation—Safely and easily rotate the shelves, locate the desired inventory item, stop at the proper position, and remove the product at floor level, without extra help
- Increased Safety—When the machine does the heavy lifting for you, the risk of injuries and muscle strains are reduced
- Higher Efficiency—Visible, organized inventory increases picking accuracy for fewer costly mistakes
- Security and Loss Prevention—Prevent unauthorized retrieval and use of the machine with an access keypad



PARTS

Who's in charge ...you or your inventory? Take back your warehouse by making parts come to you—safely and conveniently, whenever you need them.



Motorized Carousel features include wire-mesh front guarding and forward/reverse controls. Options include auto-retrieval and full enclosure.

P2418 Vertical Carousels

Carrier Size: 119" W x 24" D x 18" H

MODEL #	HEIGHT	WIDTH	DEPTH	CARRIER QTY.
P2418-10-120	12' 4"	12' 0"	6' 6"	10
P2418-11-120	13' 2"	12' 0"	6' 6"	11
P2418-12-120	14' 0"	12' 0"	6' 6"	12
P2418-13-120	14' 10"	12' 0"	6' 6"	13
P2418-14-120	15' 8"	12' 0"	6' 6"	14
P2418-15-120	16' 6"	12' 0"	6' 6"	15
P2418-16-120	17' 4"	12' 0"	6' 6"	16

P1812 Vertical Carousels

Carrier Size: 119" W x 18" D x 12" H

MODEL #	HEIGHT	WIDTH	DEPTH	CARRIER QTY.
P1812-12-120	9' 10"	12' 0"	5' 8"	12
P1812-13-120	10' 5"	12' 0"	5' 8"	13
P1812-14-120	11' 0"	12' 0"	5' 8"	14
P1812-15-120	11' 7"	12' 0"	5' 8"	15
P1812-16-120	12' 2"	12' 0"	5' 8"	16
P1812-17-120	12' 9"	12' 0"	5' 8"	17
P1812-18-120	13' 4"	12' 0"	5' 8"	18
P1812-19-120	13' 11"	12' 0"	5' 8"	19
P1812-20-120	14' 6"	12' 0"	5' 8"	20
P1812-21-120	15' 1"	12' 0"	5' 8"	21
P1812-22-120	15' 8"	12' 0"	5' 8"	22
P1812-23-120	16' 3"	12' 0"	5' 8"	23
P1812-24-120	16' 10"	12' 0"	5' 8"	24

WIRE

The ergonomic design puts reels at a comfortable working position, increasing productivity and reducing the risk of injury.

- Accommodates multiple reel diameters and widths
- Equipped with a wire-mesh front guard
- Simple, push button controls

- Wire Carousel Specs:
- Maximum Overall Capacity 13,000 lbs.
 - Maximum Carrier Capacity 1,000 lbs.
 - Electrical requirements 208V, 3PH, 60hz, 15 Amp
 - Motor Horsepower 2 x 1.0 HP
 - Off Balance Load Capacity 1,400 lbs.

- Features:
- 2" Mesh Guarding
 - Push Button Controls
 - Security Keypad
 - Main Power Disconnect
 - Modular Design
 - Loading Dolly



ROLLS

See and store your entire inventory using less square footage than traditional storage racks.

- Can be used in warehouse and floor displays
- Hinge arm loading system makes single-person loading easy
- Can be used for print material, rolled goods, parachute canvas

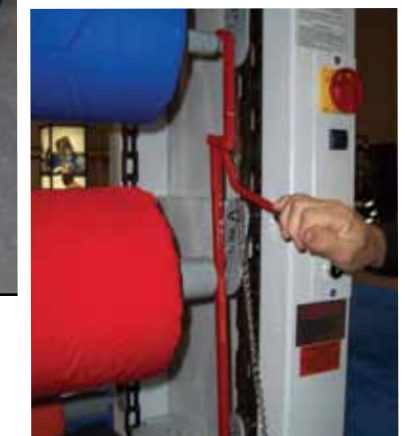

TIRES

Motorized Carousel's optional loading ramp makes it easy to safely store and retrieve tires up to 11" wide.



28" diameter tires (tire capacity based on 7" wide tire)

MODEL #	CAPACITY	CARRIER WIDTH	HEIGHT	CAROUSEL WIDTH	DEPTH
T39148-0740-SV12	147	12'7"	13'2"	14'7"	6'11"
T39188-0940-SV12	189	12'7"	16'6"	14'7"	6'11"
T39228-1140-SV12	231	12'7"	19'10"	14'7"	6'11"
T39268-1340-SV12	273	12'7"	23'2"	14'7"	6'11"
T39308-1540-SV12	315	12'7"	26'6"	14'7"	6'11"
T39148-0740-SV15	189	15'7"	13'2"	17'9"	6'11"
T39188-0940-SV15	243	15'7"	16'6"	17'9"	6'11"
T39228-1140-SV15	297	15'7"	19'10"	17'9"	6'11"
T39148-0740-SV18	224	18'7"	13'2"	20'9"	6'11"
T39188-0940-SV18	288	18'7"	16'6"	20'9"	6'11"
T39228-1140-SV18	352	18'7"	19'10"	20'9"	6'11"

32" diameter tires (tire capacity based on 9" wide tire)

MODEL #	CAPACITY	CARRIER WIDTH	HEIGHT	CAROUSEL WIDTH	DEPTH
T45156-0744-SV12	119	12'7"	14'2"	14'9"	7'9"
T45200-0944-SV12	153	12'7"	17'10"	14'9"	7'9"
T45244-1144-SV12	187	12'7"	21'4"	14'9"	7'9"
T45156-0744-SV15	147	15'7"	14'2"	17'9"	7'9"
T45200-0944-SV15	189	15'7"	17'10"	17'9"	7'9"

44" diameter tires (tire capacity based on 11" wide tire)

MODEL #	CAPACITY	CARRIER WIDTH	HEIGHT	CAROUSEL WIDTH	DEPTH
HT54162-0563-SV12	65	12'6"	15'0"	14'11"	9'4"
HT54193-0663-SV12	78	12'6"	17'7"	14'11"	9'4"
HT54225-0763-SV12	91	12'6"	20'3"	14'11"	9'4"
HT54256-0863-SV12	104	12'6"	22'10"	14'11"	9'4"
HT54288-0963-SV12	117	12'6"	25'6"	14'11"	9'4"
HT54319-1063-SV12	130	12'6"	28'1"	14'11"	9'4"



Fully motorized for quick, easy storage and retrieval, Motorized Carousel is available in a number of preconfigured sizes or can be custom-configured to your exact specifications.

TOUGH STORAGE FOR A TOUGH WORLD.

Vidmar is America's premier manufacturer of custom modular storage systems used in unlimited industries including military, automotive, manufacturing, and healthcare. Designed to keep supplies close at hand, increase overall work efficiency, and cut down on lost parts and tools, all Vidmar storage cabinets are backed by a heavy-duty lifetime warranty.

When it comes to your specific needs, a Vidmar Territory Sales Manager will analyze your space and determine the Vidmar solutions that will most benefit your organization. From there, Vidmar will help you design a custom storage installation that holds up to your toughest day-to-day demands.

Save space, save time, and save money with a premium-strength storage solution that will grow as you grow. To schedule a free site analysis, call 800-523-9462 today.

PAINT FINISH

All Vidmar® cabinets, drawers and accessories are painted with an epoxy polyester-based powder coating.

This durable coating provides:

- An improved durability to surfaces (salt spray and scratch tests)
- Improved consistency in color

This environmentally-friendly paint is available in ten standard colors at no additional charge. (Non-standard and custom colors are available with additional charges added on a per-order basis.)

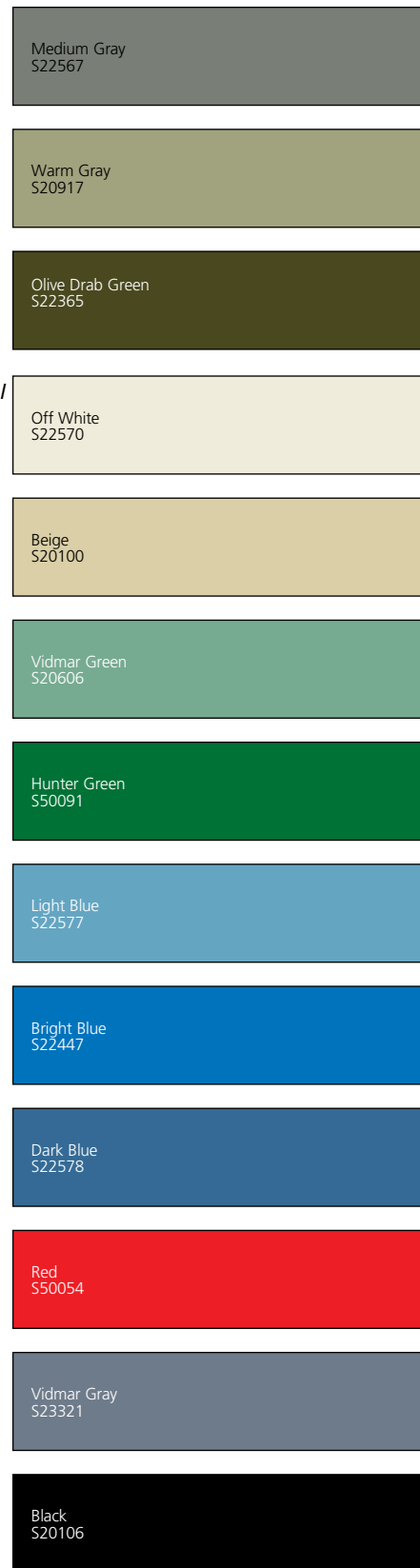

VIDMAR® QUICK SHIP ORDERING

Two day guaranteed shipment is now available on select Vidmar products.

Need to get organized fast? Vidmar will now ship a select group of popular products to you with 48 hours after ordering. Guaranteed. The Quick Ship ordering service includes preconfigured cabinets, mobile cabinets and workstations, technical benches and accessories.

VIDMAR® QUICK SHIP PRODUCTS

For a full list of Vidmar® Quick Ship products and to place an order, go online to www.STANLEYVidmar.com. Ground freight service in the Continental U.S. is free for customers.



www.STANLEYVidmar.com



QuickShip Section

LIFETIME GUARANTEE

binets are backed by a lifetime guarantee against defect of any kind. Lifetime cabinet guarantee does not cover damage caused by misuse or damage caused by use in excess of manufacturer's recommended capabilities.

These guarantees comprise the sole and entire guarantees pertaining to storage cabinets supplied by Vidmar. Vidmar makes no other warranty, guarantee, or representation of any kind whatsoever pertaining to the storage cabinets and storage equipment. All other guarantees, including but not limited to merchantability, fitness for particular purpose, and non-infringement, whether express, implied, or arising by operation of law, trade usage, or course of dealing, are hereby expressly disclaimed by Vidmar. Notwithstanding any of the provisions of this agreement or any incorporated documents, in no event shall Vidmar be liable for any exemplary, special, consequential, or incidental damages, including but not limited to loss of business or profits, loss of use, or loss of data, regardless of the form of the action, whether in contract or in tort.



Worksurfaces



Preconfigured Cabinets



Drawer Accessories



Drawer Partitions

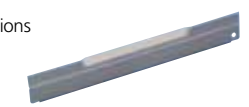

Drawer Dividers

CABINET SPARE PARTS

- Minimum Order Qty
- 1 each unless specified

MODEL #	DESCRIPTION	MODEL #	DESCRIPTION
AEROSOL PAINT			
ASP01	Vidmar Gray, #S23321	CARRIAGE BRACKETS	
ASP02	Vidmar Green, #S20606	CBLWL	Carriage Bracket w/Screw, LW, LH
ASP06	Olive Drab Green, #S22365	CBLWR	Carriage Bracket w/Screw, LW, RH
ASP07	Warm Gray, #S20917	CBSTL	Carriage Bracket w/Screw, ST, LH
ASP08	Medium Gray, #S22567	CBSTR	Carriage Bracket w/Screw, ST, RH
ASP09	Light Blue, #S22577	CBPLWL	Painted Carriage Bracket, LW-LH
ASP10	Dark Blue, #S22578	CBPLWR	Painted Carriage Bracket, LW-RH
ASP11	Bright Blue, #S22447	CBPSTL	Painted Carriage Bracket, ST-LH
ASP12	Off-White, #S22570	CBPSTR	Painted Carriage Bracket, ST-RH
ASP13	Beige, #S20100	CARRIAGE STOP LATCHES	
ASP19	Industrial Brown, #S22569	5-109-020-21	Carriage Stop Latch, LH
ASP21	StaticGard™ Black, #S6100V	5-109-020-22	Carriage Stop Latch, RH
ASP28	Safety Yellow, #S22645	CASTERS/CASTER KITS	
ASP30	Safety Yellow, #SV773	CKR5HR	Rigid, 5" Hard Rubber Wheel
ASP44	Hunter Green, #S50091	CKR6PP	Rigid, 6" Polyloc Wheel
ASP43	Red, #S50054	CKS5HR	Swivel, 5" Hard Rubber Wheel
BASE COVERS (priced each)			
BCDW	Base Cover w/Fasteners, DW or DL	CKS6PP	Swivel, 6" Polyloc Wheel
BCST	Base Cover w/Fasteners, ST or LW	046400	Swivel, 2" Stem Caster
BCSV	Base Cover w/Fasteners, SV	DRAWER PULL END CAPS	
BCXW	Base Cover w/Fasteners, XW or XL	ECDPPKG1	End Caps, Drw. Pull, Pkg. of 25 R and L
BOOKCASE			
5-138-340-02	H Clip for BS30 Shelf	ECDPPKG2V	New Style End Caps, Drw. Pull, Pkg. of 25 R and L
CABINET LABELS			
6-100-340-20	Label, Vidmar Nameplate	ECDPPKGBK	Black End Caps, Drw. Pull, Pkg of 25 R and L
047435	Label, Static Caution	DRAWER PULL KITS	
CABINET PLUG			
6-100-340-24	Plugbutton for Lock Hole	DPK901SVPKG1	901 Drw Pull Kit-SV, Pkg. of 10
CARRIAGES			
CARRDW	Carriage, DW	DPKSDPKG1	Door Pull Kit, Shelf Door, Pkg. of 10
CARRLW	Carriage, LW	DPKSTPKG1	Drawer Pull Kit, Std, Pkg. of 10
CARRST	Carriage, Standard	DPKSVPKG1	Drawer Pull Kit, SV, Pkg. of 10
CARRSV	Carriage, SV	SGDPK901	SG 901 Drw Pull Kit-SV, Pkg. of 10
CARRXL	Carriage, XL	SVDPKG1	SG Drawer Pull Kit, Std, Pkg. of 10
CARRXW	Carriage, XW	SGDPKSTPKG1	SG Drawer Pull Kit, SV, Pkg. of 10
CARRDL	Carriage, DL	SGDPKSVPKG1	SG Drawer Pull Kit, SV, Pkg. of 10
CARRSL	Carriage, SL	DPKSTPKG2BK	Drw Pull black end caps, Pkg. of 10
SGCARRST	SG Carriage, Standard		
SGCARRLW	SG Carriage, LW		



ECDPPKG1



ECDPPKG2V



ECDPPKGBK

CABINET SPARE PARTS

- Minimum Order Qty
- 1 each unless specified

MODEL #	DESCRIPTION	MODEL #	DESCRIPTION
HARDWARE			
6-100-340-25	Base Cover Fastener Kit (Qty. 2)	KEYS	
BCSCR	Base Cover Screw (each)	KEY1	Key for Vidmar Locks (specify combination)
SCRCB	Carriage Bracket Screw	KEY2	SL10 Master Key
4-168-340-05	Caster Nut	LOCK CYLINDERS	
6-160-000-14	Hardware Kit, Bench Leg	CYLDL1	Threaded Shelf Door Lock Cylinder
6-165-000-02	Laminate Plastic and Hardwood Hdwr Kit	CYLDL10	Old Style SL10 Lock Assembly
SCREWPKG	Partition Screws, Package of 100	CYLDL11	Lock Rod and Toggle, GN-10
SCRDP	Screw, Drawer Pull	RODGN10R	Lock Rod and Toggle, GN-10R
STH1	Stak Top Hardware	RODSDL135	Lock Rod Kit, SDL 135, Old Style
KEYS			
KEY1	Key for Vidmar Locks (specify combination)	RODSDL1351	Lock Rod Kit, SDL 1351, Threaded
KEY2	SL10 Master Key	RODSDL155	Lock Rod Kit, SDL 155, Old Style
LOCK CYLINDERS			
CYLDL1	Threaded Shelf Door Lock Cylinder	RODSDL1551	Lock Rod Kit, SDL 1551, Threaded
CYLDL10	Old Style SL10 Lock Assembly	RODSDL175	Lock Rod Kit, SDL 175, Old Style
CYLDL11	Lock Rod and Toggle, GN-10	RODSDL1751	Lock Rod Kit, SDL 1751, Threaded
CYLDL10R	Lock Rod and Toggle, GN-10R	RODSDL245	Lock Rod Kit, SDL 245, Old Style
RODSDL135	Lock Rod Kit, SDL 135, Old Style	RODSDL2451	Lock Rod Kit, SDL 2451, Threaded
RODSDL1351	Lock Rod Kit, SDL 1351, Threaded	RODSDL340	Lock Rod Kit, SDL 340, Old Style
RODSDL155	Lock Rod Kit, SDL 155, Old Style	RODSDL3401	Lock Rod Kit, SDL 3401, Threaded
RODSDL1551	Lock Rod Kit, SDL 1551, Threaded	RODSDL3400S	Lock Rod Kit, SDL 340, Old Style
RODSDL175	Lock Rod Kit, SDL 175, Old Style	RODSDL10	Lock Rod and Toggle, SL10
RODSDL1751	Lock Rod Kit, SDL 1751, Threaded	RODSDL10L	Lock Rod and Toggle, SL10L (Left-Hand Assembly)
RODSDL245	Lock Rod Kit, SDL 245, Old Style	RODSDL10R	Lock Rod and Toggle, SL10R (Double Toggle)
RODSDL2451	Lock Rod Kit, SDL 2451, Threaded	MR & ML LATCHES	
RODSDL340	Lock Rod Kit, SDL 340, Old Style	MLLK	ML Latch Kit
RODSDL3401	Lock Rod Kit, SDL 3401, Threaded	MRLK	MR Latch Kit
RODSDL3400S	Lock Rod Kit, SDL 340, Old Style	PAPER LABELS FOR LABEL HOLDERS	
RODSDL10	Lock Rod and Toggle, SL10	PLALH13	Paper Label, ALH13
RODSDL10L	Lock Rod and Toggle, SL10L (Left-Hand Assembly)	PLBLH	Paper Label, BLH02
RODSDL10R	Lock Rod and Toggle, SL10R (Double Toggle)	PLLH01	Paper Label, LH01
TAPE			
DTAA	Desk Top Adhesive	PLLH04	Paper Label, LH04
DST01	Double-Sided Tape for Tops	PLLH06	Paper Label, LH06

CABINET ANCHORING KITS

- For securing single cabinets to the floor (All cabinets should be securely fastened to the floor)
- Kit consists of two screws, washers and anchors
- Specify the appropriate hardware for your floor

MODEL #	DESCRIPTION
CAK-1	For concrete floors
CAK-2	For wood floors

CABINET ANCHORING KITS

MODEL #	DESCRIPTION
CCH-1	Contains 4 sets of 5/16-18 hardware to attach 2 cabinet housings side to side or 4 cabinet housings back to back
CCH-2	Contains 4 sets of 3/8-16 grade 5 hardware to attach 2 cabinet housings side to side or 4 cabinet housings back to back, recommended for seismic zone 3 and above
CCH-3	Contains 4 sets of 1/4-20 hardware to attach 2 auto technician overhead cabinet housings side to side



CCH-1



CAK-1



CAK-2

VERTICAL STORAGE PARTS

Medium Gray S22567
Warm Gray S20917
Olive Drab Green S22365
Off White S22570
Beige S20100
Vidmar Green S20606
Hunter Green S50091
Light Blue S22577
Bright Blue S22447
Dark Blue S22578
Red S50054
Vidmar Gray S23321
Black S20106

PAINTE FINISHES